

**Swedish National
Road Administration**

Road & Traffic Management Division

Date of
document
June 1996

Designation of
document Pub.
1996-036 (E)

Author

Financial & Planning Department
Condition Analysis Section Contact
person: Lennart Lindbladh

Title/series title and serial number of document

Inspection Manual

Principal contents

Inspection requirements, definitions, inspection procedure and measurements

Key words

Bridge, bridge administration, bridge types, inspection, structural members,
measurement, sampling, damage, condition.

Library notes

ISSN and key title

ISBN

Recipient

Distributor

SweRoad
Box 4202
S-171 04 SOLNA, Sweden.
Tel. Int. +46 8 757 6980. Fax Int. +46 8 294689.

Postal address
781 87 BORLANGE

Telephone
Int.+46 243 75000

Telefax
Int.+46 243 84640

Telegrams
swenatroad
borlaenge

Telex
74114
isvcfw s

BRIDGE

INSPECTION MANUAL

Published by Swedish National Road Administration,
Road & Traffic Management Division, Borlange, Sweden.
Project control by Lennart Lindbladh,
Road & Traffic Management Division,
Condition Analysis Section, Borlange

Production Stiller AB, Jonkoping, Sweden.
Printed by Tabergs Tryckeri AB, Jonkoping, Sweden.

June 1996

Translated by L J Gruber
BSc(Eng) CEng MICE MIStructE

In accordance with the Law of Copyright relating to literary and artistic works, reproduction in any form of the whole or part of this document, without the prior written consent of the Swedish National Road Administration, is prohibited.

SAFETY, ACCESSIBILITY AND EFFECTIVENESS

Systematic and regular inspection of bridges is essential to ensure that the demands of road users regarding safety and traffickability are satisfied.

STRINGENT REQUIREMENTS REGARDING COMPETENCE AND THE INSPECTION SYSTEM

The inspection system of the Swedish National Road Administration specifies stringent requirements for the competence of the inspectors, the inspection procedure and the necessary equipment

TRAINING AND COMPETENCE

The aim of this inspection manual is to train inspection personnel and to develop their competence in order that the quality requirements regarding bridge inspections should be satisfied. The manual describes the way inspections as an entity should be performed and provides guidance in this respect.

FIXED AND MOVABLE BRIDGES

The manual is mainly intended for fixed and movable bridges within the field of activity of the Sw. National Road Administration, but it can also be used by municipalities and other road authorities.

BORLÄNGE, March 1994

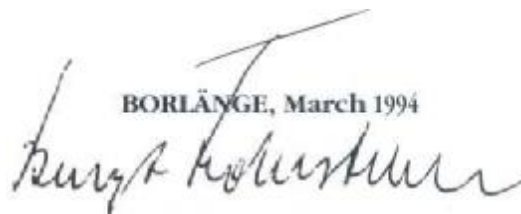

Bengt Holmstrom

BRIDGE
Bridge Inspection Manual

INTRODUCTION

AIM, SCOPE AND REQUIREMENTS

The manual relates to the inspection of fixed and movable bridges in which the theoretical span of the longest span is greater than 2.0 m. The manual describes the requirements regarding inspection, its aims, scope, frequency and the competence of the inspectors.

**BRIDGE INSPECTION DESCRIBED IN
THE GREATEST DETAIL**

The manual provides guidance regarding the way the inspections are to be carried out, and gives information on bridge types, structural members and elements, types of damage and their causes, and bridge engineering concepts. It describes how inspections are to be planned, and the equipment and plant needed.

Working procedures in the field, comprising measurements and sampling, are described from planning to completion.
Inspection documentation is described.

**METHODS OF MEASUREMENT AND CONDITION
ASSESSMENT OF BRIDGES**

Separate publication for the assessment
of physical and functional condition.

CODE SCHEDULE

Separate publication for recording inspection
results in the database of the
Swedish National Road Administration.

**A COMPLETE AID FOR
INSPECTION AND TRAINING**

I hope that this manual with its four principal chapters,
and the separate publications for Measurement and Condition
Assessment of Bridges and the Code Schedule, will be found
a useful aid for inspection and training.

Per-Arne Nilsson
Project Leader

BRIDGE

Bridge Inspection Manual

PROJECT GROUP

This manual for bridge inspection has been produced by a project group within the organisation of the Swedish National Road Administration

Bengt Aronsson

Production Division, Production East, Borlange

Jan-Olof Bolin

Road & Traffic Division, South-East Region, Jonkoping

Kerstin Ericsson

Road & Traffic Division, South-East Region, Jonkoping

Bosse Eriksson

Road & Traffic Division, Technical Department, Borlange

Kjelljansson

Road & Traffic Division, Malardalen Region, Eskilstuna

Bror Mildton

Production Division, Production East, Borlange

Bo-Gunnar Nilsson

Road & Traffic Division, West Region, Goteborg

Per-Arne Nilsson

Road & Traffic Division, South-East Region, Jonkoping

Lage Rosen

Production Division, Production Central Sweden, Ostersund

Bengt Rutgersson

Road & Traffic Division, South-East Region, Jonkoping

Hans Sunden

Road & Traffic Division, Malardalen Region, Eskilstuna

BRIDGE
Bridge Inspection Manual
CONTENTS

13-17

INSPECTION REQUIREMENTS

Aim, scope and frequency of different types of inspection.
Competence requirements for bridge inspectors.

19-77

DEFINITIONS

Definitions of bridge terms such as bridge types,
principal parts of a bridge, structural members and elements.
Physical condition, types of damage and possible causes.

79 -135

INSPECTION PROCEDURE

Planning, selection of equipment and aids,
and practical procedure.
Working environment.
Method of documentation.

137 -158

MEASUREMENTS AND SAMPLING

Measurement and test procedures for
field and laboratory investigations.

CONTENTS

TYPES OF INSPECTION (14 - 17)

Regular inspection

Aims, scope and frequency (14)

Superficial inspection

Aims, scope, frequency and competence (14)

General inspection

Aims, scope, frequency and competence (14-15)

Major inspection

Aims, scope, frequency and competence (15-16)

Special inspection

Aims, scope, frequency and competence (17)

BRIDGE
Inspection requirements
CONTENTS

TYPES OF INSPECTION (14 - 17)

Regular inspection

Aims, scope and frequency (14)

Superficial inspection

Aims, scope, frequency and competence (14)

General inspection

Aims, scope, frequency and competence (14-15)

Major inspection

Aims, scope, frequency and competence (15-16)

Special inspection

Aims, scope, frequency and competence (17)

BRIDGES
Inspection requirements
TYPES OF INSPECTION

Bridges shall be subjected to regular and systematic inspection in order to ensure that the demands of road users regarding safety and trafficability are satisfied.

The inspections shall reveal the physical and functional condition of the bridges and shall provide the basis for the planning and implementation of measures required to comply with the specified requirements in both the short and long term.

The types of inspection are as follows:

- **Regular inspection**
- **Superficial inspection**
- **General inspection**
- **Major inspection**
- **Special inspection**

REGULAR INSPECTION

AIMS

The inspection shall have the aim of detecting acute damage which may affect the safety of traffic and the integrity of the structure in the short term.

SCOPE

The inspection refers to the top of the bridge and to the road embankments on each side of the bridge.

FREQUENCY

The inspections are to be made regularly by the maintenance contractor; it is appropriate for this to be done in conjunction with the inspection of the road network.

SUPERFICIAL INSPECTION

AIMS

The inspection shall have the aim of verifying that the requirements specified in the maintenance contracts are complied with.

SCOPE

The inspection refers to those structural members and elements for which certain requirements have been specified as to their properties and the action to be taken.

FREQUENCY

The inspections are to be made by the maintenance contractor at least twice a year for bridges on the national road network and at least once a year for other bridges.

COMPETENCE

The inspections are to be made by personnel who have good knowledge of the appropriate methods of measurement and are familiar with the structural design and mode of action of the bridge.

GENERAL INSPECTION

AIMS

The inspection shall have the aim of following up the assessments, made at the time of the immediately preceding major inspection, regarding damage which has not been put right.

BRIDGES

Inspection requirements

TYPES OF INSPECTION

The inspection shall also have the aim of detecting and assessing damage which would have resulted in unsatisfactory bearing capacity or traffic safety or would have given rise to substantially increased administration costs if the damage had not been detected before the next major inspection.

The inspection shall further have the aim of checking that the requirements specified in the maintenance contracts have been complied with. Any deviations shall be measured up.

SCOPE

All structural elements except those below water level are to be inspected. Visual inspection methods may be applied.

Parts adjoining the bridge such as road embankments, slopes, abutment ends, fill, revetment and fenders are also to be inspected.

The inspection is to be carried out at such a distance, with the assistance of any optical aids which may be necessary, that the above aims are achieved.

If deviations are found from the assessments made at the time of the immediately preceding major inspection regarding damage which had not been put right, or if new damage is detected (as above), such damage is to be assessed from a distance within arm's reach in accordance with the requirements applicable for major inspection.

FREQUENCY

The inspections shall be made at intervals of not more than three years - this includes major inspection. This requirement applies only to bridges where the theoretical span of the longest span exceeds 5.0 m. For other bridges a general inspection is to be made when necessary.

COMPETENCE

The inspections shall be made by personnel who comply with the requirements specified for major inspection.

MAJOR INSPECTION

AIMS

The inspection shall have the aim of detecting and assessing defects which may affect the function of the structure or traffic safety within a ten year period. It is also the intention to detect defects which, if not remedied within this period, may give rise to increased administration costs.

The inspection shall also aim to check that the requirements specified in the maintenance contracts are complied with. Any deviations found shall be measured up.

SCOPE

All structural elements (including those below water level) are to be inspected. Visual inspection methods may be applied. Parts adjoining the bridge such as road embankments, slopes, abutment ends, fill, revetment and fenders are also to be inspected.

The inspection also covers mechanical and electrical equipment in a movable bridge.

At the time of the major inspection, the required measurements are also to be made to determine, inter alia,

- **bottom profiles**
- **chloride content and carbonation of concrete**
- **reinforcement corrosion**
- **cracking in steel structures.**



The inspection is to be carried out from a distance within arm's reach.

BRIDGES
Inspection requirements
TYPES OF INSPECTION

FREQUENCY

Inspections shall be made at intervals not greater than six years.

The first major inspection of a new bridge is to be made just before the guarantee inspection, but not later than six years after the bridge was opened to traffic.

COMPETENCE

The inspections are to be made by personnel who possess the following competence:

- * engineering training
- * training as an inspector by the Swedish National Road Administration
- * knowledge of the durability of bridge structures and the degradation processes to which these structures are exposed
- * knowledge and experience required to predict development of damage
- * knowledge and experience required to find appropriate technical and economical solutions to remedy damage
- * knowledge of Regulations for Bridges BRO 94 of the Swedish National Road Administration, Regulations for Concrete Structures BBK and Regulations for Steel Structures BSK.

For underwater inspection

it is necessary in addition to the above for the personnel concerned to have the required certificate for work under water.

For inspection of mechanical and electrical equipment the following applies in addition to the above:

- * electrical competence in accordance with the Electrical Installations Ordinance
- * knowledge required to perform trial runs on machinery and electrical equipment
- * knowledge and experience of hydraulic equipment
- * knowledge of the Swedish Regulations for the Design and Maintenance of Electrical Installations

SPECIAL INSPECTION

AIMS

The inspection is to be carried out as and when necessary to investigate in greater detail the defects which were detected or were presumed to exist at the time of the regular inspections.

An example of such investigation is pulse radar measurement for inspection of waterproofing on bridge decks.

Inspections are also made on the mechanical and electrical equipment which actuates the opening mechanism of movable bridges.

SCOPE

The inspection relates to individual structural elements and the following elements regardless of their condition:

- * mechanical and electrical equipment on movable bridges
- * butt welds in the primary loadbearing elements in steel structures. At least 30% of the welds in flange plates or similar are inspected by measuring instruments so that any internal and external defects should be detected

FREQUENCY

Mechanical and electrical equipment on movable bridges shall be made at intervals not greater than three years - this includes major inspection.

Butt welds in primary loadbearing elements are inspected in conjunction with the major inspection made prior to the guarantee inspection, but not later than six years after the bridge had been opened to traffic.

The times of inspection of other details are determined when the regular inspections are made.

COMPETENCE

For inspection of mechanical and electrical equipment, the requirements set out for the major inspection apply.

For most other inspections also, the competence requirements specified under the major inspection apply.

Specialist competence is required for instrument measurements such as

- * **Ultrasonics**
- * **Radiography**
- * **Thermography**

BRIDGE
Definitions
CONTENTS

BRIDGE TYPES - FIXED BRIDGES (20 - 29)

Slab frame bridge (20). Beam and slab frame bridge (21).
Slab bridge (22). Girder bridge (23-25). Closed spandrel arch bridge (25-26). Open
spandrel arch bridge (26-27). Culvert (27). Other bridge types (27-29).

BRIDGE TYPES - MOVABLE BRIDGES (30 - 32)

Bascule bridge (30-31). Swing bridge (31). Rolling bridge and
lift bridge (33-34).

PRINCIPAL PARTS OF THE BRIDGE (33 - 34)

Foundation, substructure and superstructure (33-34).

STRUCTURAL ELEMENTS (35 - 61)

Foundation. Base slab and sheet piling (35-36).

Slope and embankment end. Slope, embankment end, embankment, piles, pile
deck and breast wall (37-38).

Supports. Bearing seat, ballast wall, piers, solid wall piers, thrust abutment, plumbing
pegs, counterforts, run-on slabs, demolition devices and anchorages (39-41).

Wing walls and retaining walls. (42).

Bearings. Bearings, elastomeric laminated bearings, hinges (43-44). **Primary
loadbearing elements.** Slab, beam, truss, open and closed spandrel arch,
earth filled arch, side wall and culvert (45-48). **Other**

loadbearing elements. Secondary beams, crossbeams,
cross bracing, ties and wind bracing (49).

Bridge deck. Decking, orthotropic and one-way spanning plate (50-51). **Edge
beam.** Edge protection, parapet fixing, drips, levelling pegs and lighting column
brackets (52).

Waterproofing. Water vapour outlet, sealing and protection course (53).

Surfacing. Wearing course, protection course, base course and joint sealant (54).

Parapet. Posts, safety netting, splash and spray guard, fencing, struts and protective
roof (55).

Expansion joints. End section, sealing element, joint sealants, cross beams (56).

Drainage system. Subsurfacing drains, drainage channels and gulleys (57).

Other details. Fendering/dolphins (58).

Movable bridge. Machine elements, power and transmission. Other machine
elements. Control, operation and electrical system. Operating space. Bearings (59-61).

TYPES OF DAMAGE (62 - 73).

Leaching, weathering, spalling, flaking, corrosion, rotting (62-64).

**Embrittlement, cracking, flexural and tension cracks (64-65). Shear cracks,
combined flexural and shear cracks, fracture, crushing, loosening and
deformation (66-67). Misalignment, movement, scratch, dent, leakage, scour
and blockage (68-70). Rutting, holes, crazing, casting defects, blistering and
loss (70-72). Defective condition (72). Types of damage-only for movable
bridges.** Pitting, excessive play, deviation in clearance, unserviceability (73).

TERMS USED IN MEASUREMENT. (74 - 77).

Depending on whether or not they can be opened, bridges are divided into the principal types fixed and movable bridges.

The most common type of bridge in Sweden is the frame bridge. About one half of the bridges of the Swedish National Road Administration are of this type. They are of one or more spans and are made of reinforced concrete.

Frame bridges may be slab bridges or beam and slab bridges.

SLAB FRAME BRIDGE

This bridge is characterised by the fact that the bridge deck is rigidly fixed at both ends into the abutments of the bridge. The abutments are carried by the base slabs.



Span

The most common type of slab frame bridge has one span and is in most cases made of reinforced concrete in spans of up to ca 22-25 m. For larger spans, up to ca 35 m, prestressing is used.

The road embankment, the backfill to the bridge, terminates at the rear of the breast wall. The duty of the earth pressure exerted by the backfill is to counteract the pressure on the legs when the bridge slab is loaded.

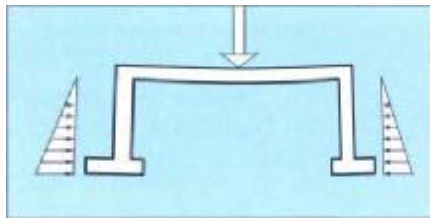

Raft foundation

On soil of low bearing strength and for small spans, the frame bridge is sometimes constructed with a raft foundation. A bracing construction may also be provided between the base slabs for the legs when foundation conditions are difficult.

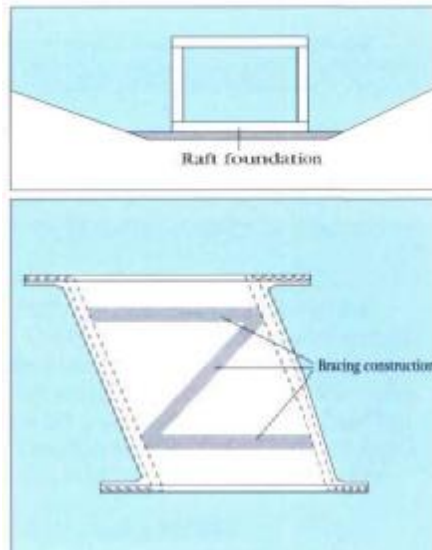

Wing walls

The wing walls are fixed into the breast walls of the bridge. They may be either parallel to the longitudinal direction of the bridge or splayed. In most cases they are splayed.



The primary loadbearing element

is usually constructed as a homogeneous slab, but ribbed and voided slabs may also be used. Slab frame bridges are usually made of reinforced concrete.

BRIDGE TYPES - FIXED BRIDGES

BEAM AND SLAB FRAME BRIDGE



The function of the beam and slab frame bridge is the same as that of the slab frame bridge.

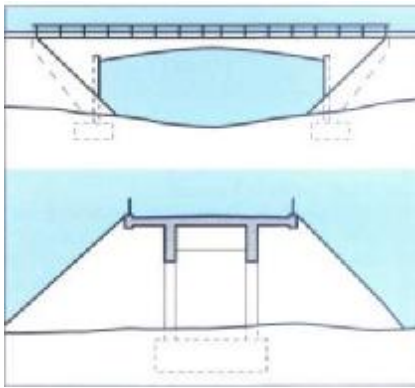

The superstructure of the bridge is designed as a beam construction and its depth of construction is therefore greater.

The bridge is mostly made of reinforced concrete. (RC).

Span

The RC beam and slab frame bridge is seldom built today. It has been superseded by the slab frame bridge for shorter spans and by the girder bridge for longer spans.

Previously it was used for spans of ca 25-30 m.

Prestressed concrete beam and slab frame bridges can be constructed with single spans up to 40-50 m.

Frame beams

The frame beams are rigidly fixed into the abutments, the legs of the frame. In older beam and slab frame bridges it is usual for the main beams to continue down into the legs and to cantilever out beyond the supports and thus replace the wing walls.

In such a case the beams are also

integral with the bridge slab and are terminated at each end by crossbeams.

Breast wall

Between the frame legs there are breast walls which, together with the bridge slab, ensure the stability of the structure in the transverse direction.

In older beam and slab frames the soffits of the beams are usually constructed to variable radii (haunched).

The road embankment

slopes from the crossbeams to the breast walls between the frame legs. Outside the legs the end of the abutment is rounded off.

Frame legs

The beam and slab frame bridges of today have frame legs constructed as a slab, often of a cross section that tapers downwards. The wing walls are fixed into the legs. The deck beams are either of constant depth or are haunched. The beams are fixed into the legs.

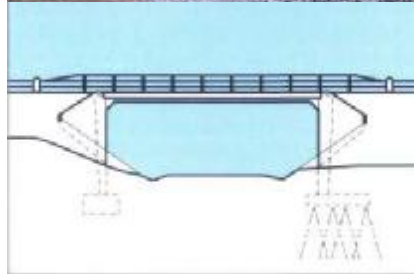

BRIDGE INSPECTION
Definitions
BRIDGE TYPES - FIXED BRIDGES

SLAB BRIDGE

Slab bridges are used where the available construction depth is limited.



Span

The slab bridge is made of reinforced concrete in spans up to ca 25 m and prestressed concrete in spans up to ca 35 m. The bridge deck is usually of constant thickness along the entire length of the bridge.

Simply supported or continuous

The slab bridge may be simply supported or continuous. In a continuous bridge the bridge slab passes uninterrupted over the piers.

The simply supported slab bridge

is in most cases a single span bridge and consists of a superstructure, a slab, supported on the abutments and the piers.

The continuous slab bridge

also consists of a slab supported on the abutments and the piers. The piers may be constructed as solid wall piers or as columns.



Slab bridges with a total length up to ca 70 m

are often constructed without real abutments. The slab is fixed into or supported either on solid wall piers or columns, and rests directly on the road embankment which is retained by a curtain wall. Smaller wing walls may also be fixed to this curtain wall.

A bridge with high level base slab at the ends

is a variant of the slab bridge. In this case the foundation for the base slab is protected by an end wall on the superstructure to prevent horizontal forces from acting on the base slab. This type of bridge is also constructed as a beam and slab bridge.



This method of foundation is mainly used near water so that the foundations and the base slabs may be constructed in dry conditions. It is usual for the base slab to be carried on piles.

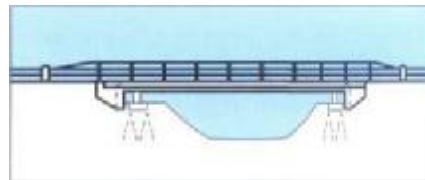

Bridge with inclined piers

A special type of continuous slab bridge is that with inclined piers. The bridge normally has three spans. Owing to the horizontal forces exerted by the inclined piers, the construction requires a subsoil of very good material. Inclined piers are also to be found on beam and slab bridges.

BRIDGE INSPECTION
Definitions
BRIDGE TYPES - FIXED BRIDGES
than 70 m.



BEAM AND SLAB BRIDGE

The main beams of the beam and slab bridge are constructed of reinforced concrete, prestressed concrete or steel.

Spans

Reinforced concrete is used for spans up to ca 25 m.

Prestressed concrete is used from approx. 20 m.

At present, welded steel beams compete with prestressed concrete beams from ca 35 m. Both older and more recent steel beam bridges with rolled sections are constructed for shorter spans.

Simply supported or continuous

The beam and slab bridge may be simply supported or continuous. At all times, this type of bridge has had a very broad field of application; its origin is the tree trunks laid over streams. When the existing supports can be used, rolled steel beams are sometimes used in reconstructing bridges.



The superstructure

in such a case consists of two or more steel beams supported on bearings at the abutments. The bridge deck is carried on top of the beams. The beams are connected by bracing which provides lateral restraint.

The continuous concrete girder bridge

is constructed both with bearings over the piers and with the piers fixed into the main beams.

In the same way as in the case of the slab bridge, the concrete girder bridge can be constructed without real abutments if the total length is less



Box section members

are used for long spans, when head-room is restricted or when the superstructure may be acted on by torsional moments, for instance in bridges carried on single piers.

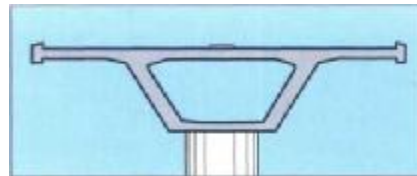

For very long spans

box section beams are constructed as cantilevers. In this case the beam soffits are heavily curved.

The steel beam bridge usually has a bridge deck of concrete with or without structural interaction with the steel beams.



Interaction is ensured by welding shear connectors, studs, to the top flanges of the beams.

BRIDGE INSPECTION

Definitions

BRIDGE TYPES - FIXED BRIDGES

Steel box members can also be used for the same reasons as concrete box members, but they are not very common .



Good foundation conditions

For an earth filled arch bridge, good foundation conditions are essential, so that the thrust abutments are stable and harmful settlements are prevented.



Fig. Concrete arch bridge

EARTH FILLED ARCH BRIDGE

Earth filled arch bridges are our oldest bridges. They are considered by many to be the most beautiful bridges we have.

The first bridges were built using natural stone. Hewn stone gradually came to be used, sometimes with mortar in the joints.



Strengthening of stone arches

The stone arch and side walls can be strengthened by adding reinforced concrete on the inside

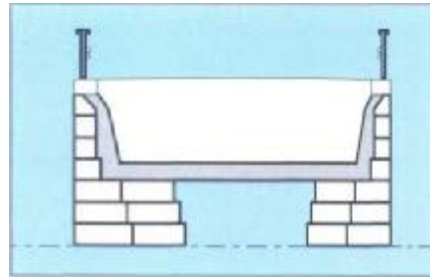

. Fig. Strengthening

The principal elements of the bridge

The earth filled arch bridge may be divided into the following principal elements: the thrust abutments, the arches with earth fill and the side walls. The thrust abutments correspond to the bank seats of the girder bridge, and the arch with the earth fill corresponds to the superstructure.

Stone or concrete structure

The earth filled arch bridge is usually made of stone or reinforced concrete. Combinations of different materials are also used, for instance stone in the abutments and concrete in the arches, or abutments and arches of concrete with stone facing.

There are still a small number of unreinforced earth filled arch bridges.

OPEN SPANDREL ARCH BRIDGES

The open spandrel arch bridge is a development of the closed spandrel arch bridge. The earth fill is replaced by vertical columns which carry the bridge deck.

In an arch bridge most of the load is carried by compression in the arch. Only a small proportion is taken up by flexural moments.



BRIDGE INSPECTION

Definitions

BRIDGE TYPES - FIXED BRIDGES

Depending on the level at which the bridge deck is placed, an arch bridge can be constructed in different ways.



In bridges of the bowstring type the bridge deck is carried by hangers which are anchored in the arch rib.

Where there are two main arch ribs these are connected by cross bracing which provides lateral stability and also resists wind forces.



Open spandrel arch bridges were previously used for spans over ca 60 m, but this span range has nowadays been taken over by prestressed concrete bridges and steel girder bridges. An open spandrel arch bridge is usually constructed of reinforced concrete or in combination with steel.

The closed spandrel arch rib bridge is a variant of the arch bridge. The vertical side walls which carry the bridge deck are cast on the arch ribs.

CULVERTS

Culverts are usually made from rolled corrugated sheeting which are bent into the required shape. The sheet thickness varies depending on the span but is usually between 3 and 7 mm. Spans are up to 7 m. Most culverts are however smaller.



The function of the culvert

is provided by interaction between the sheeting and the surrounding soil. Culverts are made to different cross sections such as vertical ellipses, low depth sections or pedestrian tunnels.

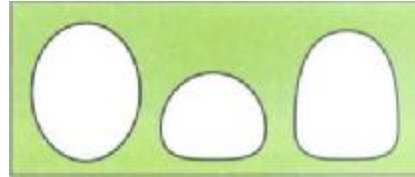

Hot dip zinc coated sheeting

The sheeting is protected against corrosion by hot dip zinc coating which may be complemented by an additional protective coat of e.g. epoxy paint which is sprayed on top of the zinc coating.

For smaller spans, culverts are also made of reinforced concrete pipes. The mode of action of these is different from that of the sheeting culverts which are flexible. In this case it is the rigid reinforced concrete structure which resists most of the load.

OTHER TYPES OF BRIDGE

Examples of other types of bridge are truss bridges, suspension bridges, cable stayed bridges and prefabricated bridges of different types.

TRUSS BRIDGE

The truss bridge consists of a system of members which transmit the load to the substructure by compression or tension.



The truss bridge is primarily used today as a pedestrian bridge or a temporary bridge.

BRIDGE INSPECTION
Definitions
BRIDGE TYPES - FIXED BRIDGES

PREFABRICATED CONCRETE BRIDGES



SUSPENSION BRIDGE

A suspension bridge may be considered to be an "upside down" open spandrel arch bridge with the carriageway on top. Instead of compressive forces in the arch rib, there is tensile force in the suspension cable. The columns are replaced by hangers. The cables are supported on the towers, and the tensile force is transmitted to anchorages in the ground.



CABLE STAYED BRIDGE

In cable stayed bridges the bridge deck is carried by cables anchored on top of the towers.



Suspension and cable stayed bridges are used only for very large spans.



Prefabricated concrete bridges may be either slab bridges or beam bridges. Slab bridges are mainly used over pedestrian and cycle paths. Beam bridges are used for larger spans and usually have an in situ concrete bridge deck.

Reconstruction

Both concrete slabs and beams are used in reconstructing existing bridges which are to have a new superstructure.

Slabs are made for spans up to ca 6 m and beams are made in lengths up to ca 35 m.

A start has also been made on using prefabricated slabs with transverse joints across the bridge. These slabs are laid on main beams, usually of steel, and the joints between the slabs are filled with concrete.

BRIDGE INSPECTION
Definitions
BRIDGE TYPES - MOVABLE BRIDGES

There are four different types of movable bridge at present, bascule bridges, swing bridges, rolling bridges and lift bridges.

The most common movable bridges are bascule bridges, swing bridges and rolling bridges.

BASCULE BRIDGES

The bascule bridge is one that turns about a horizontal trunnion. There are three principal types: fixed trunnion bascule bridge, rolling lift bascule bridge and drawbridge. The last type has evolved from the mediaeval drawbridge.



FIXED TRUNNION BASCULE BRIDGE

Single leaf bridge

The bridge acts as a balanced system, with a longer arm over the waterway and a shorter one carrying a counterweight. The nose of the bridge rests on bearing pads. Some bascule bridges have nose locks which engage with the support.

Double leaf bridges

Double leaf bridges are fitted with nose locking arrangements which take up the shear forces where the leaves meet. Tail bearings are mounted at the tail ends of the main beams and on the roof of the tail chamber.

ROLLING LIFT BRIDGE

This bridge is carried on curved rollers which roll on special tracks. The force which creates the movement is transmitted into the centre of the curved roller by special draw bars. An alternative type has drive bars which engage with the centre of the counterweight.

Many bridges have hydraulic jacks at the tail end. At the nose of single leaf bascule bridges there are bearing pads and nose locks.

In double leaf bascule bridges there are nose locks which take up the shear forces, and bearing pads at the tail end of the main beams.

DRAWBRIDGE

These bridges differ from the previous types in having the counterweight placed on a separate balance arm above the roadway.

The bridge turns about a fixed trunnion at the tail end of the main structure. At this end there are also two columns on which the balance arms with counterweights are placed.

The torsional force is exerted by draw bars fitted between the balance arms and the leaf.

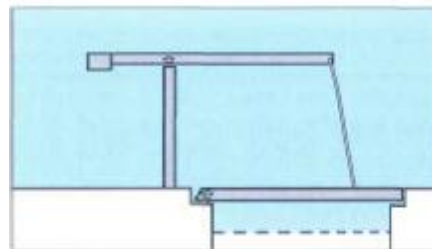

Fig. Drawbridge.

BRIDGE INSPECTION
Definitions
BRIDGE TYPES - MOVABLE BRIDGES

SWING BRIDGE

The swing bridge moves about a vertical pivot. There are two types, the balanced cantilever type and the bobtail type (shorter tail span).

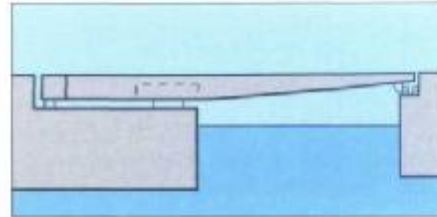

Fig. Bobtail type swing bridge.

ROLLING BRIDGE

In its simplest form, the rolling bridge consists of a simply supported span supported at one end on rollers. When opened, the bridge retracts in the longitudinal direction of the road. At one end, the bridge has an access ramp while the other end, when in the roadway position, rests on bearings.



BALANCED CANTILEVER TYPE

The bridge has two leaves of the same length which can span two waterways. A through waterway passage is usually provided only in one of the openings.

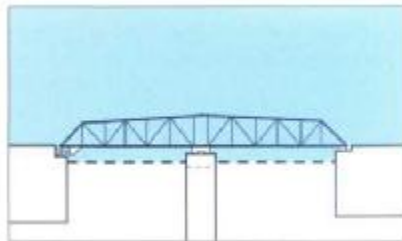

Fig. Balanced cantilever type swing bridge.

BOBTAIL TYPE

The bridge has a shorter tail span. It is preferably used on sites where a narrow canal is to be bridged and space is restricted.

In order that the centre of gravity should coincide with the centre of rotation, the shorter span must have a counterweight.

BRIDGE INSPECTION
Definitions
BRIDGE TYPES - MOVABLE BRIDGES

LEFT BRIDGE

The bridge consists of a simply supported span. When opened, the bridge is raised vertically. This construction provides limited headroom for shipping.

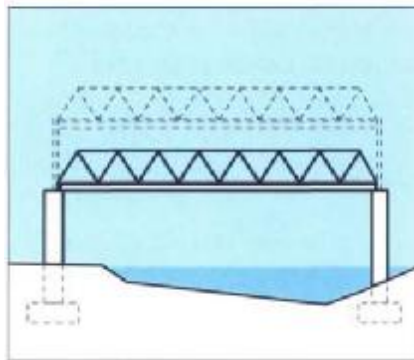
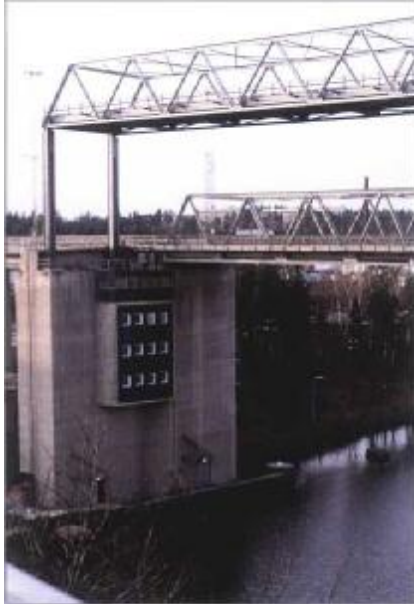

A bridge is divided into three principal parts:

foundation, substructure and superstructure. The structural members which make up each principal part, and their main functions, are described below.

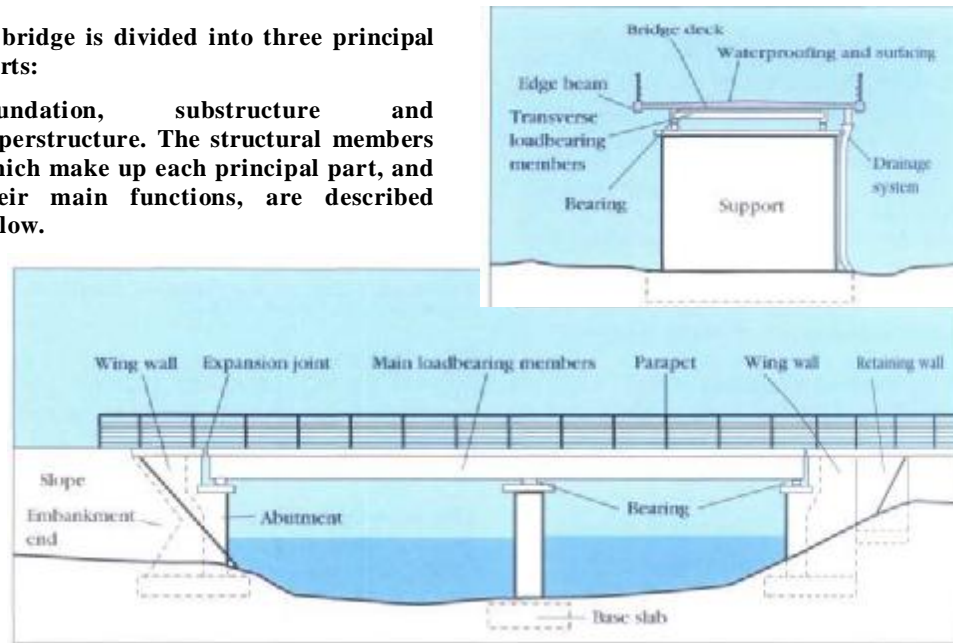

FOUNDATION

In an inspection context, the term foundation refers to the interface between the base slab and the support. In contrast to Bro 94, in this case the base slab is thus assigned to the foundation.

The foundation shall be capable of resisting the loads transmitted from the substructure.

The base slab, revetment, fill, caissons, natural ground, piers, piles, grillages, sheet piling and rock filled caissons are regarded as parts of the foundation.

SUBSTRUCTURE

Structural members situated above the foundation and below the superstructure, such as abutments, piers, breast walls etc, and in the case of slab frame bridges the members below the construction joint between the frame leg and the bridge deck, are considered to form part of the substructure. In an inspection context, curtain walls for e.g. bridges with high level base slabs are taken to be part of the substructure.

Edge beams on abutments and similar are assigned to the superstructure.

Slopes and embankment ends

are considered to be part of the substructure. Their duty is to resist earth pressure and provide support for the road embankment, breast wall, columns, wing walls and retaining walls.

In addition, the slope and embankment end prevent scour and protect adjoining structures from moving ice and flowing water.

The supports

- abutments and piers - transmit the load from the superstructure down to the base slab, sometimes via a bearing. The supports comprise the breast walls, bearing seats, ballast walls, column piers and solid wall piers, thrust abutments and counterforts.

Wing walls and retaining walls

prevent the earth fill from sliding out sideways.

SUPERSTRUCTURE

Parts of the bridge situated above the supports are regarded as the superstructure. In the case of slab frame bridges, the boundary between superstructure and substructure is formed by the construction joint between the frame leg and the bridge deck, or where there is no construction joint, by the horizontal section at the end of the haunch at the breast wall.

Bearings

transmit the load from the superstructure to the substructure.

The primary loadbearing elements

carry the load in the longitudinal direction of the bridge and transmit this to the substructure, sometimes via a bearing.

The primary loadbearing elements comprise beams, arch ribs, spandrel walls, trusses, suspenders, cable stayed beams, slabs (which may act both as main).

Other loadbearing elements

transmit or disperse the load from the element concerned to the primary loadbearing elements. The other loadbearing elements comprise secondary beams, ties, cross beams, cross bracing and wind bracing.

The bridge deck

takes up traffic and other loads and transmits these to the primary loadbearing elements.

Edge beams

provide support for the parapet and sometimes also act as loadbearing elements, for instance in the case of cantilever decks.

The waterproofing

forms a watertight barrier which prevents penetration of salt, water etc down into e.g. the bridge deck.

The surfacing

disperses the load from traffic and acts as a wearing course and protection for e.g. the waterproofing.

The parapet

provides protection against e.g. vehicles driving off the bridge and distributes any collision loads through structural interaction with other parts of the parapet over a long distance.

Expansion joints

shall be able to take up any longitudinal and angular movements and bridge the gap between different parts of the superstructure or between the superstructure and substructure. The expansion joints shall further

protect structural elements situated further down from e.g. salt water.

The drainage system

removes water from the bridge deck. In some cases it drains water from the entire bridge structure in order to protect structural elements situated further down.

This section describes structural members on fixed and movable bridges. For each structural member a number of elements are described.

THE FOUNDATION takes up the loads transmitted from the substructure.

BASE SLAB

The base slab transmits the load from the substructure to the subsoil, in some cases via piles.

STRUTTING

eliminates the effect of the horizontal force on the foundation and thus makes it possible for the foundations to be made smaller.

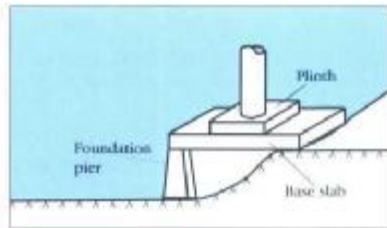

FOUNDATION PIERS

carry the base slab or similar if the distance to rock is moderate. The volume to be excavated is less than if the whole rock face must be exposed.

PLINTHS

act in some cases as a beam which spreads the concentrated loads from the columns into a more uniformly distributed pressure on the base slab.

ROCK FILLED BOX CAISSON

The rock filled box caisson is a "base slab" made up of timber walls and floor which is filled with rock. The caisson may be carried on piles.

FILL - fill in box caisson

TIMBER WALL - "wall" of box caisson

TIMBER FLOOR - "floor" of box caisson.

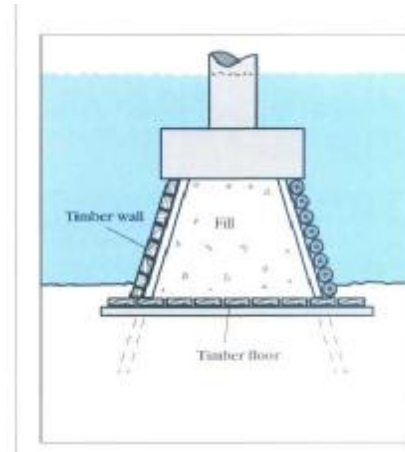

A GRILLAGE

of timber or similar material is constructed between e.g. the base slab and the subsoil and spreads the pressure over a larger area.

A grillage is used mainly where foundation conditions are "poor", in most cases in older structures such as stone arches, stone abutments and similar.

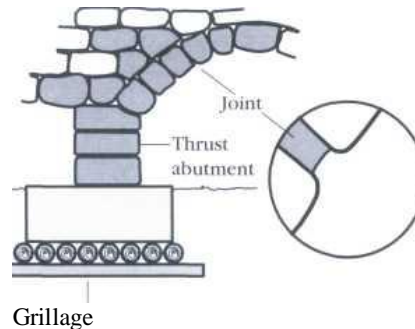

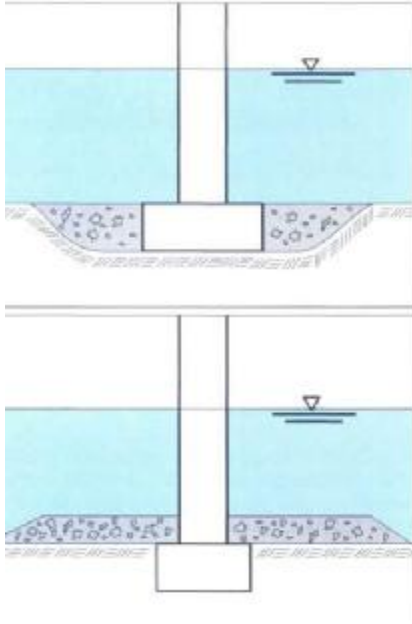
**FILL**

is material spread on the natural ground or the bottom of the excavation.

RIP-RAP

is a layer constructed of e.g. fill or concrete whose duty is to protect foundations and subsoil against scour, erosion, moving ice etc.

SHEET PILING

Sheet piling is normally used only during construction. It may however have to be left in place for several reasons. Permanent sheet piling usually has an appreciably shorter life than the rest of the bridge. There are three different "types" of sheet piling:

Temporary sheet piling

is used during construction and is removed when the bridge is finished.

Lost sheet piling

is temporary sheet piling that has not been removed. It has no function.

Permanent sheet piling

functions either as a loadbearing element or as revetment.

STRUCTURAL MEMBERS - SLOPE AND EMBANKMENT END

SLOPE AND EMBANKMENT END have the duty of resisting e.g. earth pressure and providing support for the road embankment, breast wall, columns, wing walls and retaining walls. They also prevent scour and provide adjoining structural elements with protection against moving ice and flowing water.

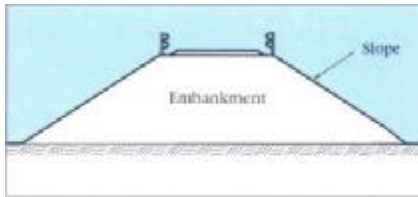

SLOPE

The term slope mostly refers to the lateral termination of the access embankment.

SURFACING

is provided because slopes and embankment ends must be protected against erosion by surface water, movement of ice, etc.

EMBANKMENT END

The slope on the access embankment is usually terminated by a rounded portion in front of the abutment. In the same way as the abutment, this acts as support for the embankment and on river banks it also provides protection against erosion and scour of the base slab.

EMBANKMENT

The embankment transmits traffic loads, dead weight etc to the subsoil. The embankment is in contact with the bridge through the breast wall, end curtain wall or similar structure.

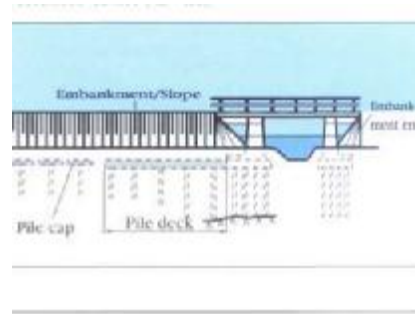

PILES

Piles transmit load from the base slab, pile deck or pile cap to the subsoil. They are used in "poor" foundation conditions, for instance on clays and similar soils.

THE PILE CAP,

in bridge structures, usually connects the heads of piles in a group. It is normally constructed as a base slab for a support. The term pile cap is also used in conjunction with e.g. road embankments where it refers to a rectangular slab cast around a single pile.

PILE DECK

A pile deck is a continuous structure constructed underneath e.g. a road embankment to carry the load down to subsoil of greater bearing strength, in the same way as the pile cap in bridge structures.

SUPPORTS transmit the load from the superstructure to the base slab.

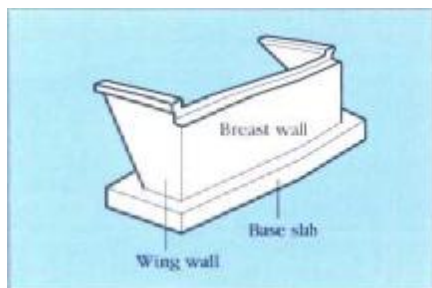

BREAST WALL

The breast wall directly transmits the load from the superstructure to the base slab and resists the earth pressure exerted by the road embankment.

CONSTRUCTION JOINTS

are used in practically all concrete structures. The number and positions of construction joints are determined on the basis of design, practical and aesthetic considerations, concreting capacity and the setting time of the concrete.

EXPANSION JOINTS

also called movement joints, are necessary in most large structures. The most important duty of expansion joints is to divide the structure into a number of smaller parts, the movements of each of which are accommodated by the joints.

In most cases these joints are filled with an elastic material which provides a seal and accommodates the movements.

JOINTS

In contrast to the types of joint described earlier, which are provided for design or construction reasons, the term joint without a qualifier refers to a gap or a layer which connects or separates e.g. the stones in a stone arch or a masonry structure. See the illustration on p. 36.

EMBEDDED FIXTURES

are devices intended to fix inspection ladders, signs and protective roofs to the bridge deck etc.

BOND

describes different ways of placing bricks etc in masonry structures.

SNECK

small stone for wedging and similar purposes in stone structures.

ANCHOR BAR

Iron bar which projects through the structure and is locked in place with an anchor plate and a cramp. (Cf today's Dywidag bars).

BEARING SEAT

The bearing seat is the surface on which the bearings are placed.

THE BEDDING MORTAR

transmits the load from the bearing to the bearing seat.

THE LIP

with its drip protects the structural elements situated below from unnecessary wetting.

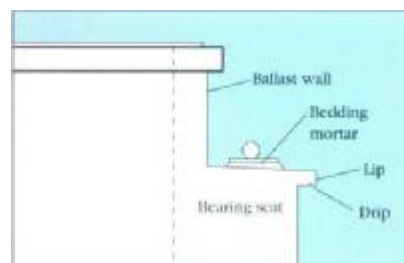

BALLAST WALL

The ballast wall is situated immediately behind the bearing seat and resists e.g. the earth from the upper part of the adjoining embankment.

The curtain wall at the end of bridges with high level base slabs is regarded as a ballast wall for purposes of inspection.

PIERS

The piers transmit the load from the superstructure to the base slab.

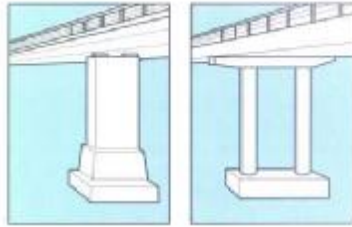

CROSS BRACING is the structural member which connects e.g. arch ribs. Cross bracing which connects the tops of columns in a bridge pier is called a cross head, and the structural member on top of the base slab which connects the bottoms of pier columns is called a plinth. The plinth is considered to be part of the substructure

COLUMN HEAD The top of the column in a pier may be flared to improve transmission of load, shear force, from the superstructure to the column. The slab adjoining the top of the column may also have a drop.



SOLID WALL PIER

A solid wall pier transmits the load from the superstructure to the base slab. A solid wall pier is defined as an element with its width equal to or greater than five times its thickness ($B \geq 5 * T$).

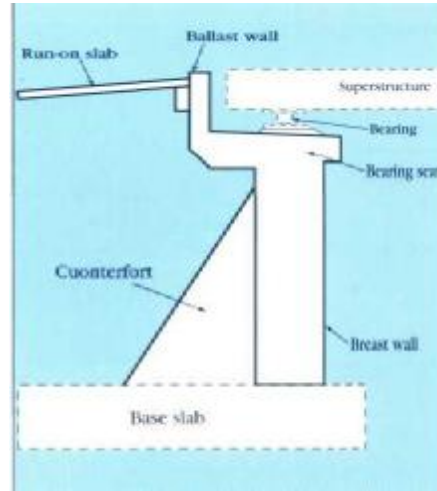
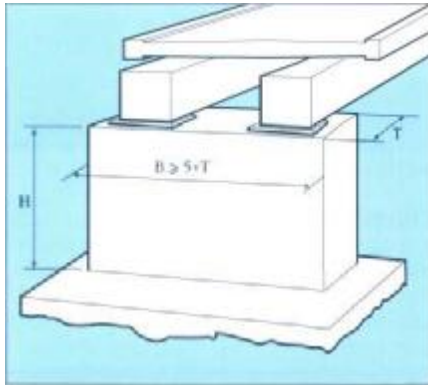

THRUST ABUTMENT

A thrust abutment takes up and resist the thrust from an arch or similar structure. See the illustration on p. 36.

PLUMBING PEG

A plumbing peg is used to check whether displacements have occurred in the structure. See the illustration on p. 42.

COUNTERFORT

In relatively high abutments the breast wall needs very large dimensions. For this reason it is therefore usual to stiffen the breast wall with counterforts. They relieve the breast wall of part of the load and also support it, and transmit load to the base slab.

RUN-ON SLAB

The run-on slab is supported on a projection at the rear of e.g. the leg of the frame and has the duty of taking up settlement in the embankment near the bridge.

The run-on slab is also provided to protect electric cables and other services which enter the bridge deck from the impact of the vehicle.

DEMOLITION DEVICE

Demolition devices are placed in e.g. beams, arches, piers or at the rear of the abutment, so that the bridge can be destroyed rapidly in an emergency.

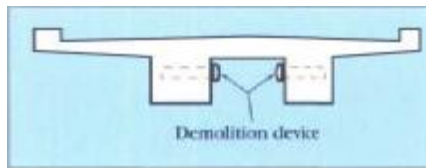
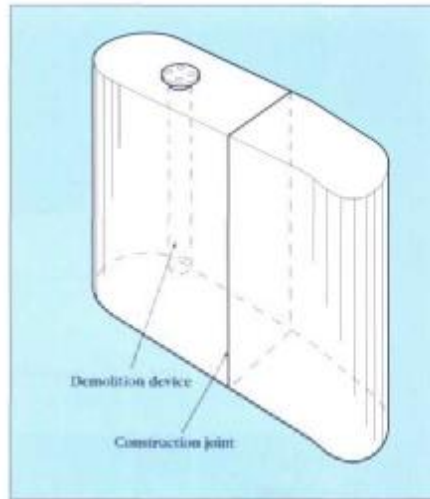

Sheet pile walls, retaining walls, abutments etc are stabilised by being anchored at the rear in the soil or rock.

STRUCTURAL MEMBERS - WING WALLS AND RETAINING WALLS

WING WALLS AND RETAINING WALLS prevent the earth fill from spilling out at the sides.

WING WALLS

The wing walls support the embankment and make it possible for the bridge to have a shorter span.

RETAINING WALLS

Retaining walls are often provided as freestanding extensions of the wing walls.

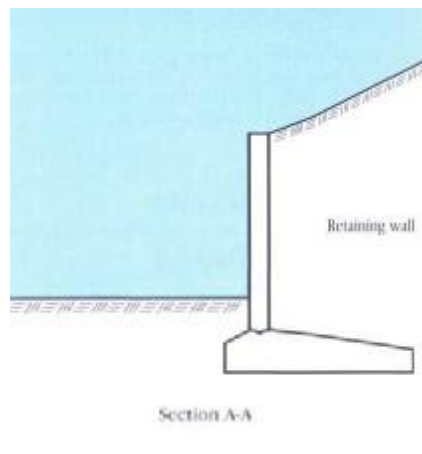
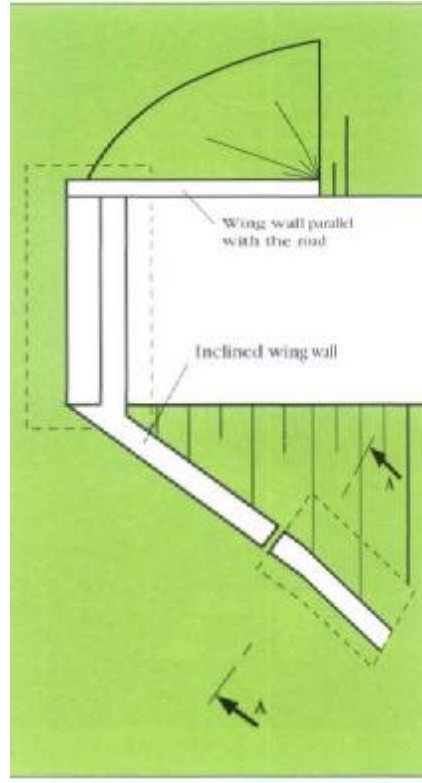
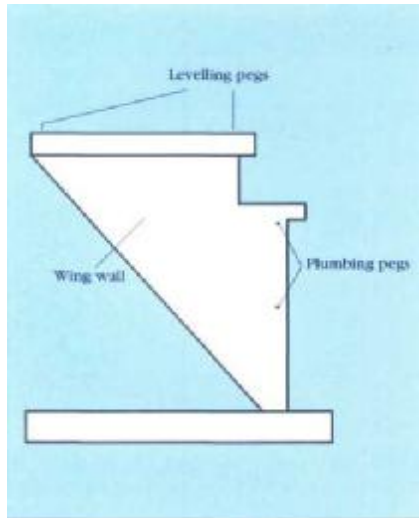

BEARINGS transmit the load from the superstructure to the substructure.

Bridge Code 88, Appendix No 6-1, gives a brief review of a number of bearing types together with a description of their function and construction.

BEARINGS

Bearings transmit the load from the superstructure to the substructure.



Fig. a. Upper bearing plate b. Roller c. Lower bearing plate d. Guide bar e. Locating bar

SLIDING BEARING

Bearing incorporating sliding elements or sliding surfaces with very low friction in the area of contact under pressure. This bearing permits horizontal movements due to relative displacement between the surfaces in contact.

SPHERICAL KNUCKLE BEARING

This comprises an upper and lower segment of the same radius. This type of bearing permits rotation by sliding between the mating surfaces.

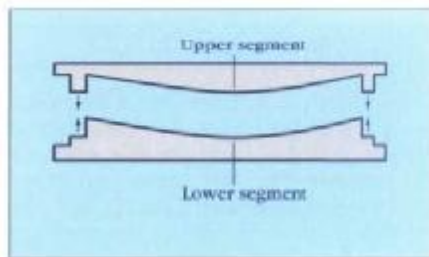

FELT

is used in many cases in older single span bridges as a simple bearing pad. See the illustration on p. 44 which shows a concrete hinge. A layer of felt is placed between the concrete surfaces to prevent bond.

ELASTOMERIC LAMINATED BEARING

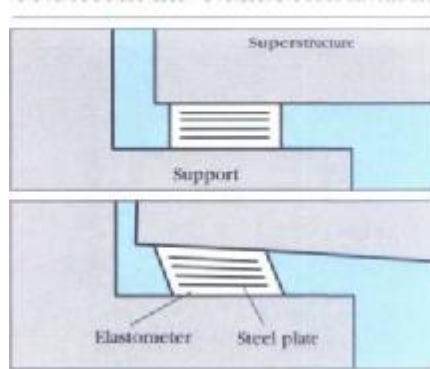

Elastomeric laminated bearings are made up of a number of equally thick layers of an elastomer with intermediate reinforcing steel plates bonded to the elastomer.

STEEL HINGE

A steel hinge is installed in e.g. cantilever box girder bridges constructed with tee shaped sections at the ends of the cantilevers for the transmission of shear forces (simple shear joint). The term hinge is also used in e.g. steel columns. The function of these is the same as that of hinges in concrete.

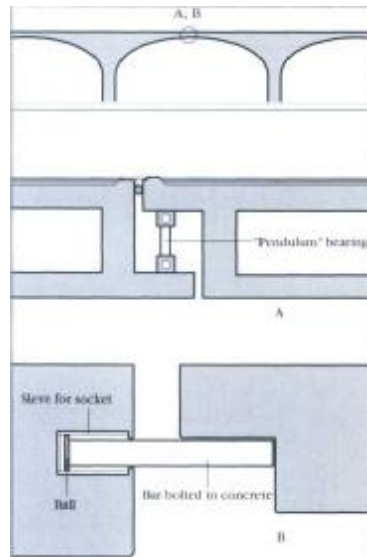

CONCRETE HINGE

A concrete hinge is constructed to provide a structural detail which does not transmit any moment.

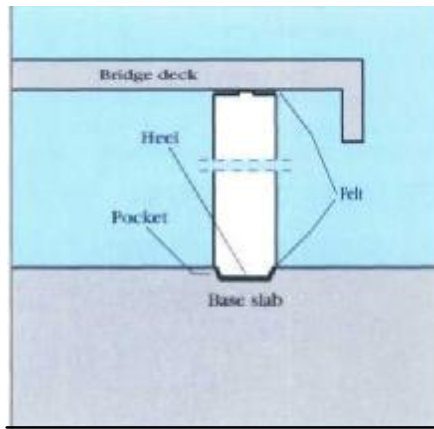

COLUMN PINNED AT BOTH ENDS

The column bearing transmits compressible forces, but cannot take moments or tensile forces.

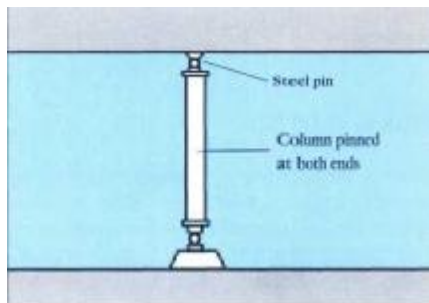

BRIDGE INSPECTION

Definitions

STRUCTURAL MEMBERS- PRIMARY LOADBEARING ELEMENTS

THE PRIMARY LOADBEARING ELEMENTS carry the load in the longitudinal direction of the bridge and transmit the load to the sub-structure.

SLAB

Slab - primary loadbearing element. A slab is defined as an element with its width greater than five times its depth ($B > 5 * H$).

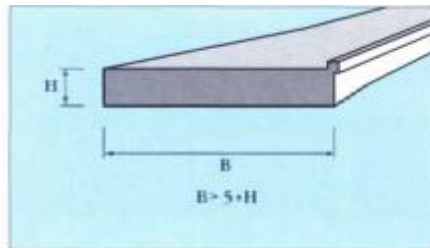

A HAUNCH

is provided to transmit shear is thickening of the slab at a support. The haunch is provided to transmit shear forces and moments at these sections.

EDGE PROTECTION

protects corners and edges which may be damaged by abrasion or collision with vehicles.

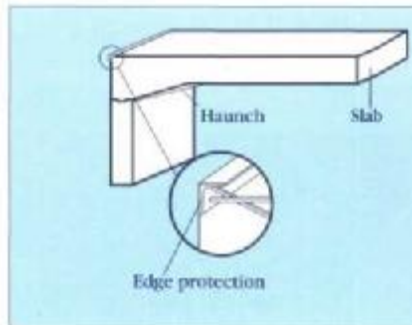

BEAM

with its width smaller than or equal to five times its depth ($B < 5 * H$).

HAUNCH - see above.

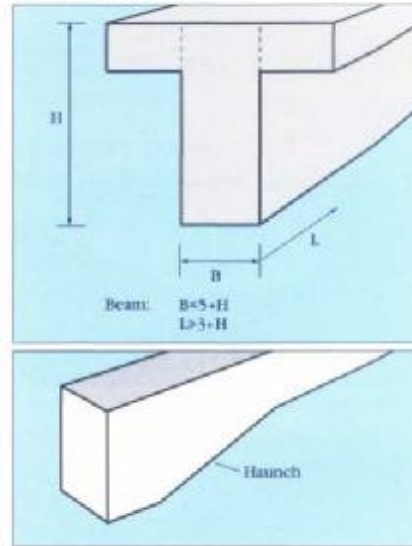

A CONNECTION

is an arrangement for the transmission of force at a section where a steel beam etc is to be spliced. A connection may be welded, riveted or bolted.



BRIDGE INSPECTION

Definitions

STRUCTURAL MEMBERS- PRIMARY LOADBEARING ELEMENTS

AN ANCHORAGE BLOCK

is a detail in which a prestressing cable is anchored. Because the web of a beam or a slab is often narrow, an external block is provided to anchor the cable. External anchorage blocks are also used when bridges are strengthened.

Note that before the weld metal is deposited, the prepared surface is referred to as a joint. The term notch is used for the recess formed in the steel at points where welds intersect.

WEB / FLANGE / STIFFENER

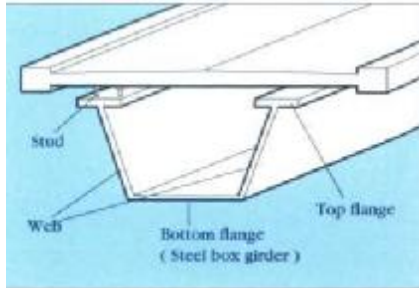

Fig. Steel box girder.

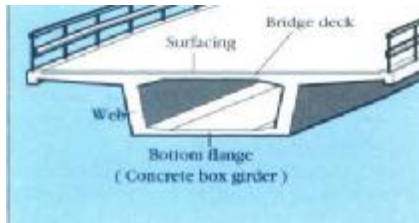
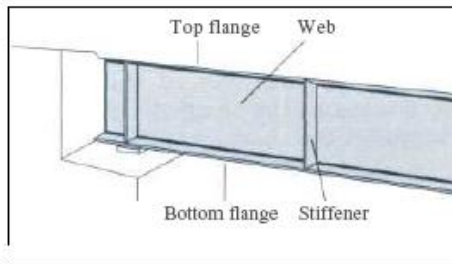

Fig. Concrete box girder.



A FILLET WELD

is a weld at an angle formed by two workpieces.

A BUTT WELD

is a weld between two workpieces which are situated substantially in the same plane.

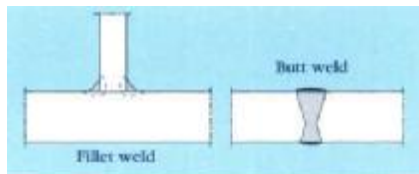

Definitions

STRUCTURAL MEMBERS-PRIMARY LOADBEARING ELEMENTS

TRUSS

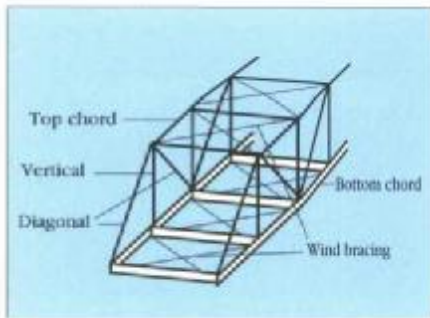

AN ARCH

may also be constructed as a truss.

ARCH

Arches are usually designed as rigid or two pinned arches. Arches are generally shaped so that the line of thrust is almost central, i.e. the moment due to the permanent load is zero.



SUSPENDERS

support the bridge deck when it is situated below the arch.



Fig. Suspenders.

SPANDREL COLUMNS

transmit the load from the bridge deck to the arch rib when the deck is situated above the arch.

BOWSTRING BRIDGE

In this structure, the arch and bridge deck form an integral unit, with the deck functioning as the tie.

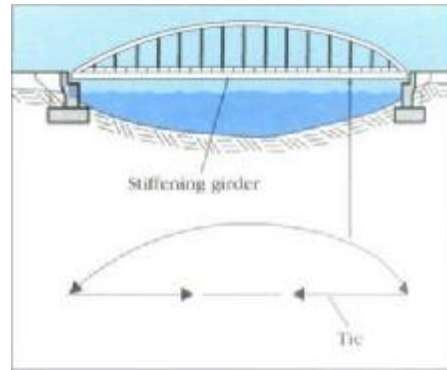

STIFFENING GIRDER

distributes/spreads concentrated loads from the traffic over a greater length of the arch.

SUSPENDER DAMPERS

are damping devices which counteract oscillations/vibrations/fatigue in the suspenders. They are in most cases provided in the form of horizontal connectors between the suspenders.

CLOSED SPANDREL ARCH BRIDGE

In a closed spandrel arch bridge the bridge deck is carried on top of the spandrel walls.

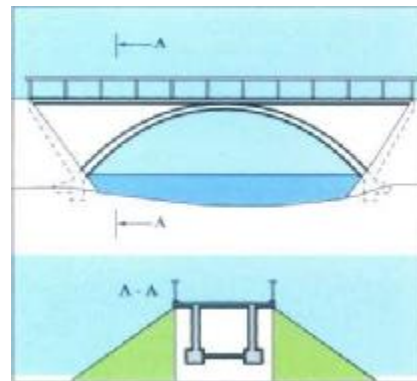

EARTH FILLED ARCH BRIDGE

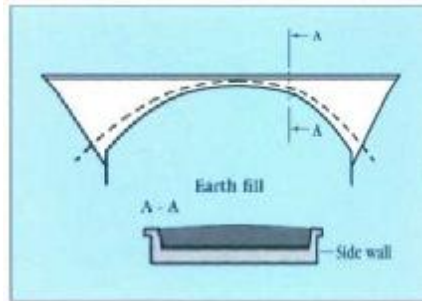

An earth filled arch bridge is a massive structure which is usually made of stone or concrete. These bridges usually have no separate bridge deck, but the arch carries side walls which retain the earth fill on which the wearing course is laid. The arch slab in these bridges is often strengthened with a concrete slab.

SIDE WALL

A side wall is a retaining wall in earth filled arch bridges.

CULVERTS

may be made of steel or concrete.
See also p. 27.

OTHER LOADBEARING ELEMENTS
transmit or disperse the load to the primary loadbearing elements.

SECONDARY BEAMS

A secondary beam is an element which transmits load to the primary loadbearing elements.

CROSS BEAMS

Cross beams are situated at right angles to the main beams.

CROSS BRACING

See above under cross beams. The beams connecting arch ribs in bridges of the bow string type are also referred to as cross bracing. See also the section "Bridge types", p. 26.

WINDBRACE

Between the top or bottom chord members of truss bridges (in larger bridges between both top and bottom members) windbraces are provided. These consist of horizontal members which have the duty of transferring to the supports the action of wind and other horizontal forces acting at right angles to the bridge.

BRIDGE INSPECTION

Definitions

STRUCTURAL MEMBERS- - DECK SLAB

THE DECK SLAB carries traffic and other loading and transmits this to the primary loadbearing elements.

VOIDS

may be formed in concrete deck slabs for cable ducts, electric cables or during construction for constructional reasons.

EDGE STIFFENING

The edges of the deck slab are stiffened, for instance by locally increasing the slab thickness. Edge beams in cantilevers are one example of these.

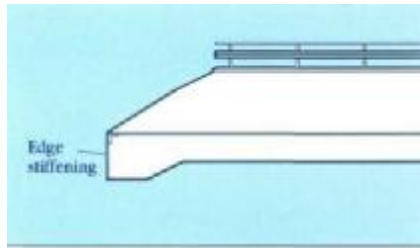

DECKING

Decking made of timber or aluminium is described below.

BRACED TIMBER DECK

This comprises structural timbers placed on edge. It is usually given a simple surfacing.

DECKING PLANKS

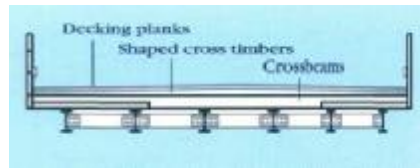

form the surfacing on a timber bridge.

SHAPED CROSS TIMBERS

are used to give the bridge deck the correct slope.

UNDERLAY FELT

is placed between the steel girders and the timber construction.

CONNECTORS

are nails, bolts, beams etc which join e.g. planks to one another or to the loadbearing steel structure.

CROSSBEAMS

of timber carry the load between the steel girders.

AN ALUMINIUM DECKING

performs the same function as a timber decking. The construction of these two types of decking is however entirely different.

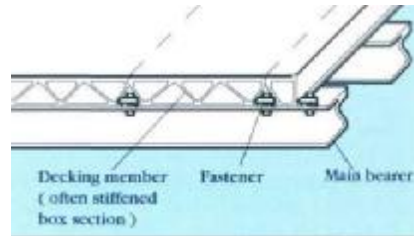

ORTHOTROPIC PLATE

Steel bridge decks usually consist of a steel plate with underlying longitudinal stiffeners (orthotropic plate). These longitudinal stiffeners (secondary longitudinal girders) are usually made continuous by making recesses in the transverse girders. The deck plate constitutes the top flange of both the main girders, the transverse girders and the longitudinal stiffeners. The orthotropic plate carries its load in "two" directions.

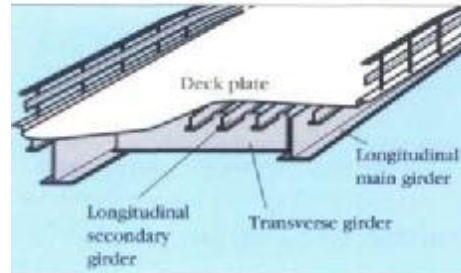

ONE-WAY SPANNING PLATE

In this form of construction, the steel plate is carried on transverse girders between the loadbearing main girders. A one-way spanning plate transmits the load from the deck plate to the main girders via the transverse girders which run at right angles to the main girders. A one-way spanning plate carries load in "one" direction, at right angles to the main girders.

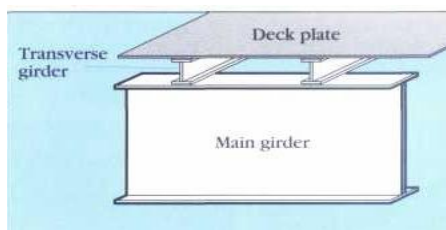

BRIDGE INSPECTION

Definitions

STRUCTURAL MEMBERS- - EDGE BEAMS

THE EDGE BEAM acts as support for the bridge parapet and in some cases as a loadbearing element, for instance in deck slab cantilevers.

EDGE PROTECTION

The edge protection is a strip of steel and protects the "edge" of a structural element, for instance the inside corner of an edge beam, from abrasion or collision by a vehicle. It is mainly provided on older structures.

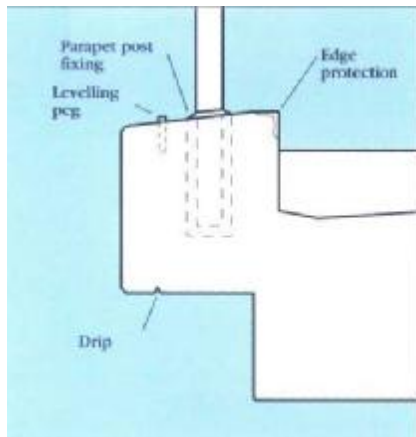

PARAPET FIXING

The point where the parapet post is cast into the edge beam or some other element.

DRIP

The drip on the soffit of the edge beam etc causes water running down the side of this to fall off.

LEVELLING PEG

Levelling pegs are inserted to provide a means of checking whether movements have occurred in the construction.

LIGHTING COLUMN BRACKETS

form the base for lighting columns.

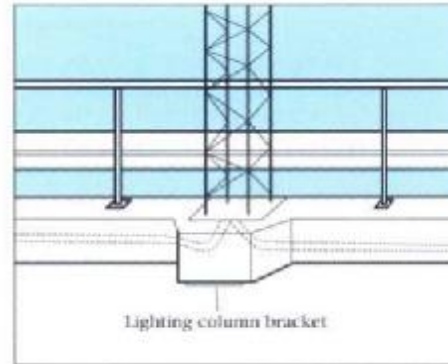

WATERPROOFING forms a watertight barrier which prevents penetration of water into parts of the structure situated below.

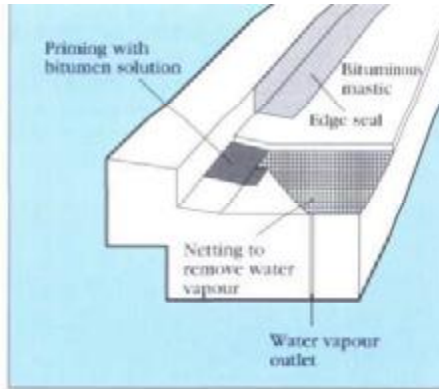

Fig. Bituminous mastic waterproofing

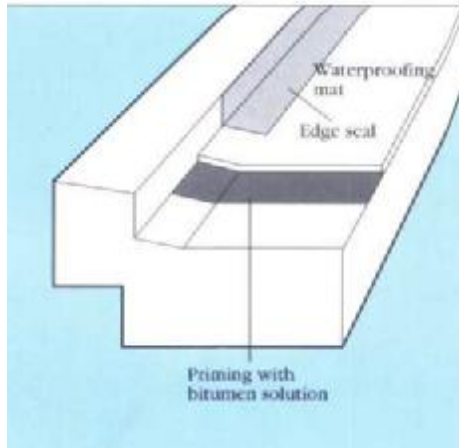

Fig. Waterproofing mat.

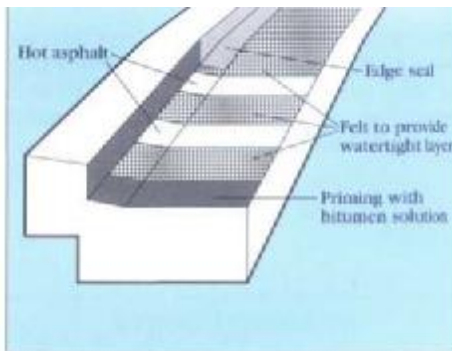

Fig. Membrane waterproofing

WATER VAPOUR OUTLET

The water vapour outlet removes water vapour, with the help of the netting, when the bituminous mastic is laid.

EDGE SEAL

This provides a seal to prevent penetration of water at the edges of the waterproofing.

PROTECTION COURSE

The protection course protects the waterproofing when the hot surfacing is laid. It also protects it from damage caused by the machinery used at this time. On a membrane waterproofing, the protection course is in the form of a concrete screed.

THE SURFACING spreads the traffic load and constitutes a wearing course and protection for e.g. the waterproofing and the structure situated below.

WEARING COURSE

The wearing course may be asphaltic concrete, gravel, concrete or decking planks. A concrete wearing course is cast either directly on top of the structural concrete or on top of waterproofing laid above the structural concrete. The wearing course is the topmost part of the surfacing and is abraded by traffic.

SPREADER COURSE

The spreader course spreads the traffic load and acts as protection for the lower courses in the surfacing when the wearing course is replaced. It may be combined with the protection course and laid directly on the waterproofing. For the protection course, refer to the section on waterproofing.

BASE COURSE

The base course has the same function as the spreader course but consists of bituminous gravel. Gravel is also used.

JOINT SEALANT

The joint sealant shall, without cracking or losing contact with the sides of the joint, be capable of accommodating the movements and loads to which it is exposed. Joint sealant is used in joints in e.g. a concrete protection course, asphalt or concrete surfacings and at the junction between the surfacing and e.g. the edge beam and the expansion joint.

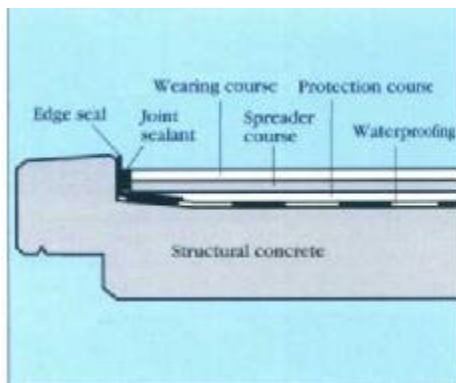

BRIDGE INSPECTION

Definitions

STRUCTURAL MEMBERS- - PARAPET

THE PARAPET provides protection against vehicles driving off the bridge and spreads the load due to a collision by means of interaction over a long distance.

POST

The parapet post is cast into the edge beam. Posts are also made of stone or concrete.

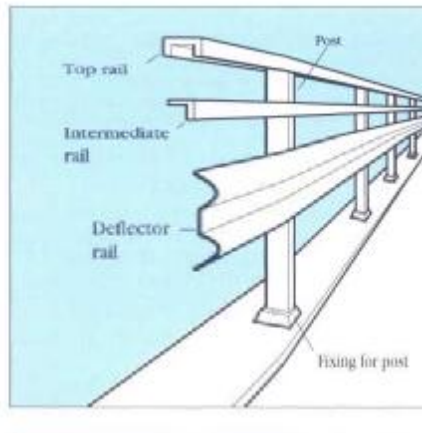

SAFETY NETTING

The duty of safety netting is to protect roads, railway tracks etc below the bridge from falling objects, gravel, snow and similar.

SPLASH AND SPRAY GUARD

The duty of the splash and spray guard is to protect pedestrian and cycle paths below the bridge from splash and spray caused by traffic.

FENCING

This is provided along pedestrian bridges where it is judged that there are special accident risks.

STRUTS

These are provided on each side of expansion joints in the parapet to transmit forces from the top rail to the edge beam.

PROTECTIVE ROOF – RAILWAYS

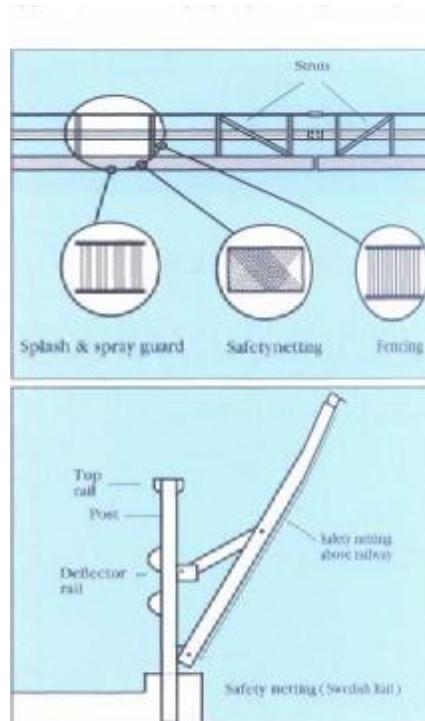

This is provided above the overhead lines of electrified railways.

BRIDGE INSPECTION

Definitions

STRUCTURAL MEMBERS- - EXPANSION JOINTS

EXPANSION JOINTS shall be able to take up any longitudinal and angular movements and bridge the gap between different parts of the superstructure or between the superstructure and substructure. The expansion joints shall further protect structural elements situated further down from e.g. salt water.

Bridge Code 88, Appendix 6-3, gives a brief description of different types of expansion joints.

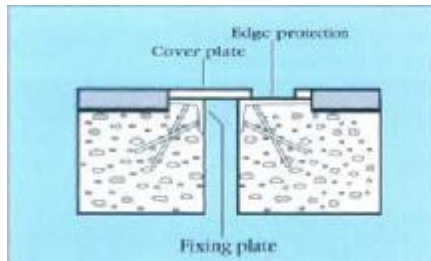
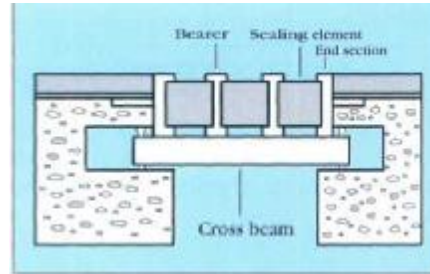

END SECTION

The end section is the part of the expansion joint which is cast into the adjacent construction and, with its claws, keeps a sealing element in place.

SEALING ELEMENT

The sealing element is an elastomeric section (in the shape of a strip, box, tube, elastomeric mat etc) which connects the end sections and acts as a seal to prevent water etc from penetrating down to structural elements situated below.

JOINT SEALANT

This protects e.g. elastomeric sections, provides a seal around the heads of bolts etc.

CROSS BEAMS

Where the seal is made up of a number of elastomeric sections side by side, these are carried by cross beams.

BRIDGE INSPECTION

Definitions

STRUCTURAL MEMBERS- - DRAIN AGE SYSTEM

THE DRAINAGE SYSTEM removes water from the bridge deck.

SUB-SURFACING DRAIN

The sub-surfacing drain removes water which has collected in the surfacing on top of the waterproofing

.DRAINAGE CHANNELS

Drainage channels are channels in the surfacing, filled with crushed rock, which collect and remove water to the sub-surfacing drains (on areas carrying traffic, epoxy bound crushed rock is used).

GULLEYS

Gulleys remove water from the carriage-way.

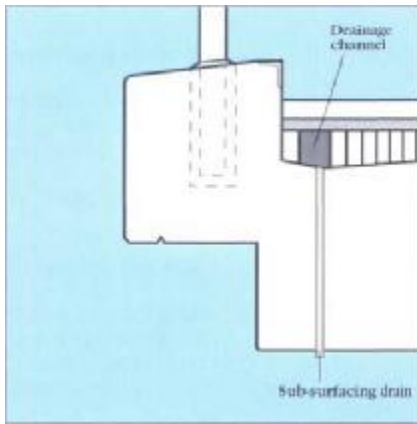
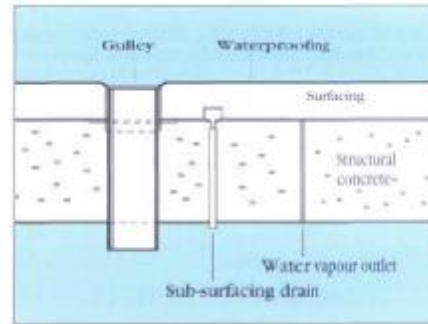

BRIDGE INSPECTION

Definitions

STRUCTURAL MEMBERS- - OTHER DETAILS

THE HEADING 'OTHER DETAILS' contains the structural elements associated with a bridge (fendering, dolphins, dam constructions, inspection devices and electrical installations) which are not described elsewhere in this chapter.

FENDERING/DOLPHINS

The function of fendering is to guide shipping past the bridge and to protect adjacent structures from being rammed. Fendering often comprises a number of dolphins connected by fenders.

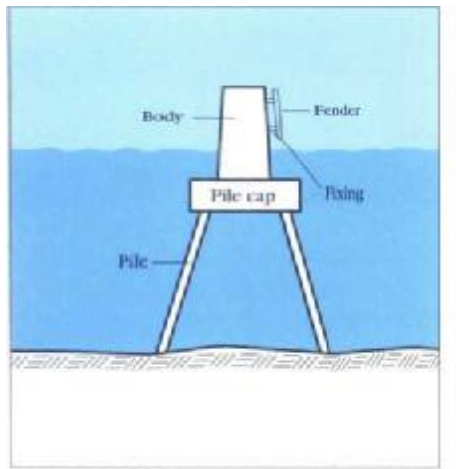

Fig. Dolphin

STRUCTURAL MEMBERS- - MOVABLE BRIDGES**MACHINE ELEMENTS, POWER AND TRANSMISSION**

Elements which form part of the machinery that generates and transmits the power required for the bridge to be movable.

Power plant

The part of the machinery which generates the power to move the bridge.

Hydraulic motor

In principle, a hydraulic motor is a pump in reverse, i.e. it transforms hydraulic energy into mechanical energy. It is used for the operation of swing bridges and rolling bridges.

Hydraulic unit

Unit comprising motor/motors, pump/pumps, oil tank, valves and filters. The unit generates power for cylinders and hydraulic motors.

Hydraulic transmission

Machinery driven by hydraulic motors and cylinders which, after the power plant and the control system, transmits the force required for the bridge to be movable.

Proportional valve

Valve in which the position of the piston is proportional to the actuating current. It is fitted in a closed circuit control system. Either load or hydraulic force can be controlled. Can also be used to control pressure.

Mechanical transmission

Mechanically driven machinery which, via a power plant, transmits the force required for the bridge to be movable.

Friction roller

Roller with friction elements fitted along its circumference. Is used on rolling bridges where torque is transmitted by friction between the flywheel and the roller.

Gearing

Two or more gear wheels in engagement.

Rack and pinion gear

The pinion engages with a straight length of toothed gearing. A rack and pinion gear is used, for instance, in transmitting the force from the driving gear to the lifting leg.

Driving gear

The gear wheel/rack which transmits the drive.

Rack drive

A rack which is in engagement with a gear wheel and with the counterweight on the bridge mechanism. The rack lifts or lowers the bridge. It is used on bascule bridges.

Wire rope

A wire rope consists of a number of wires twisted together to form strands which are laid around a central core to form the completed rope.

Roller track

A roller track comprises, inter alia, a rolling surface for transmission of vertical loads and gearing for moving the superstructure when the bridge is in operation. A roller track is mounted horizontally on the support.

Roller segment

A roller segment comprises, inter alia, a curved element with a rolling surface and gears which, during rotation, engage with gears on the roller track. The segment is mounted on the bottom flange of the main girder.

Hydraulic ram

A hydraulic ram which, when the bridge is nearly in the road traffic position, lifts the tail end (counterweight) so that the nose or tail of the bridge "rests" on the bearing pads at the nose or tail in such a way that a definite pressure is exerted on these.

OTHER MACHINE ELEMENTS**Tail locking arrangement**

Moving rollers fixed at the tail of one leaf of a bascule bridge which engage with a counterbearing mounted on the main girders.

BRIDGE INSPECTION

Definitions

STRUCTURAL MEMBERS- - MOVABLE BRIDGES

Nose locking arrangement

Moving rollers fixed at the nose of one of the leaves in a bascule bridge which engage with a counterbearing mounted on the other leaf. The duty of these locking arrangements is to take up the shear force due to the dead weight of the leaf/leaves and traffic load.

Centering block

Centres a swing bridge when this approaches the road traffic position.

Centering recess

The seating into which the centering block is inserted before the rams push the bridge up into the road traffic position.

Damper

Vertical dampers damp the motion of the centering block when it leaves the recess.

Horizontal dampers damp the motion of the centering block.

CONTROL, OPERATION AND ELECTRICAL SYSTEM

Elements for operating the bridge, external and internal communication, signaling and road closure.

OPERATING SPACE

Spaces for operation, steel constructions, counterweight and machinery.

BEARINGS

Bearing pads

Fixed bearings fitted at one end of all types of bridge with the exception of double leaf bascule bridges. These bearings take up dead weight and traffic load.

Tail bearings

Bearings fitted at the tails of double leaf bascule bridges.

Wedging blocks

Blocks fitted on swing bridges outside the roller track along the projection of the centre line. The duty of the wedging blocks is to take the load off the pivot when the bridge is in the road traffic position.

Hydraulic ram seating

Seating fitted at the tails of the main girders. Their duty is to provide a seat for the hydraulic rams.

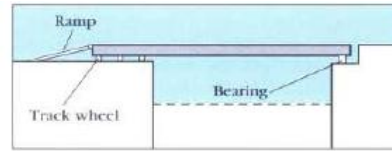

Fig. Rolling bridge.

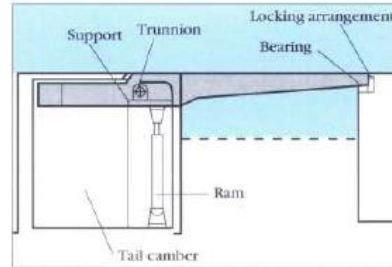

Fig. Fixed trunnion bascule bridge.

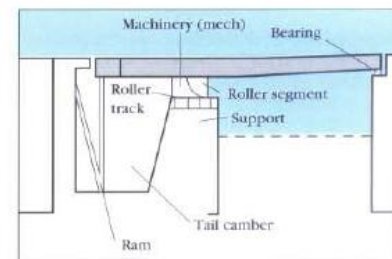

Fig. Bascule bridge with roller track.

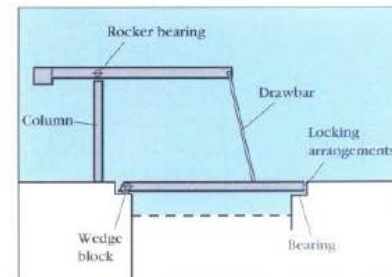

Fig. Drawbridge.

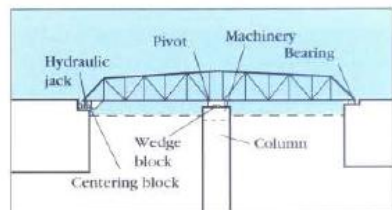

Fig. Balanced cantilever type swing bridge.

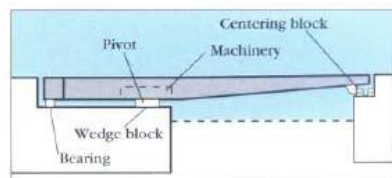

Fig. Boattail type swing bridge.

BRIDGE INSPECTION

Definitions

STRUCTURAL MEMBERS- - MOVABLE BRIDGES

This section describes the types of damage which may occur on bridges. Each type is defined by text and photograph. A brief explanation regarding the likely cause of the damage is also given.

LEACHING



The concrete has become deficient in cement paste due to leaching. Efflorescence often occurs. Cohesion between cement paste and aggregate remains even though the bond is weakened. Leaching is normally caused by water (environmental action).

WEATHRING



There is no cohesion between aggregate and cement paste. Weathering is in most cases due to chloride attack, the action of frost or abrasion caused by water or ice.

SPALLING

Concrete with its cohesion preserved which splits off in sheets or becomes stratified as a result of internal forces. Spalling may be caused by frost action and traffic loading, and as bond failure over reinforcement splices.



FLAKING

This occurs only on paint layers and epoxy seals.



Flaking is caused by environmental action and often also by the choice of wrong materials or inadequate preparation, i.e. building or maintenance defects.

CORROSION

Corrosion occurs due to reaction between metals and their surroundings, causing conversion to other substances - corrosion products - oxides sulphides



For corrosion to occur, there must be access to oxygen and water.

BRIDGE INSPECTION

Definitions

TYPES OF DAMAGE

EMBRITTLEMENT

In structural elements of concrete, corrosion on reinforcing steel is caused mainly by carbonation or the penetration of chlorides, often in combination with inadequate cover to the reinforcement. Corrosion which causes pitting deeper than 1 mm is referred to as deepseated rust.



Embrittlement causes a material to lose its natural elasticity.

Embrittlement of waterproofing or joint sealant is caused mainly by environmental action.

On structural elements of steel, corrosion is caused by environmental action, chemical attack, which may be aggravated by lack of maintenance, for instance around parapet posts.

CRACKING

ROTTING



Rotting occurs when timber is decomposed by fungi and bacteria. For rotting to occur, there must be access to oxygen and water.

Rotting is caused mainly by environmental action, biological attack. Rotting may be aggravated by e.g. a drop in groundwater level since this also exposes the timber to oxygen.

Attack by marine borers on piles is defined as rotting.



Cracking causes a material to divide into pieces of varying sizes.

Cracking is in most cases caused by some form of loading. Cracking which cannot be defined as any of the types of cracking set out below is noted down under this type of damage, for instance cracking in stone courses or cracking/crazing in waterproofing/surfacing.

FLEXURAL CRACKING

Cracking which has occurred due to a bending moment which has exceeded the flexural strength of the material, i.e. due to service conditions. The most common cause is traffic loading.

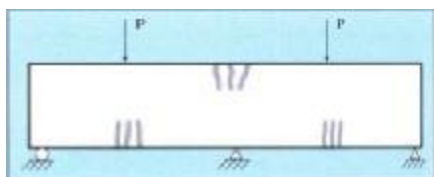

Flexural cracking occurs, for instance, on the soffit of the superstructure at midspan and at the top near supports.

Cracking can also occur in other places, for instance where reinforcement has been curtailed. It cannot occur in the compression zones of a structure. If crack width is acceptable, it is an indication that the reinforcement functions as intended.

TENSION CRACKING

Tension cracking occurs where the tensile strength of the material has been exceeded. Cracking is caused by service conditions - loading due to shrinkage/temperature or settlement in the concrete during production.

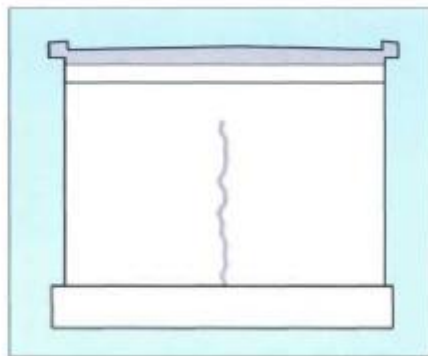

Cracking may occur over the whole of the cross section or in parts of this.

Shrinkage cracks

Shrinkage is contraction of concrete due to drying. Shrinkage cracks are often straight and have no special orientation.

Their length varies from a few tenths of a millimetre to 1-2 m, and they may be very deep.

Temperature cracks

During the setting of concrete, temperature cracking can occur due to the development of heat by the cement if movement of the concrete is prevented. These cracks may be through cracks or occur in the form of surface cracking.

Through cracking can occur in large structures where high temperatures may arise, but also in structures of more moderate dimensions such as bridge beams, abutments and retaining walls.

Surface cracking in most cases occurs in an irregular pattern and has little depth, < 0.1 mm (crazing).

Cracking may also occur in service. Cracking in e.g. box girders is due to the large temperature difference between the inside and outside of the box.

Settlement cracks

occur owing to segregation of water and are found particularly at the junction between frame leg and superstructure and at places where there are changes in section. The crack depth is normally small, but the width may be large, up to 5 mm.

SHEAR CRACKING

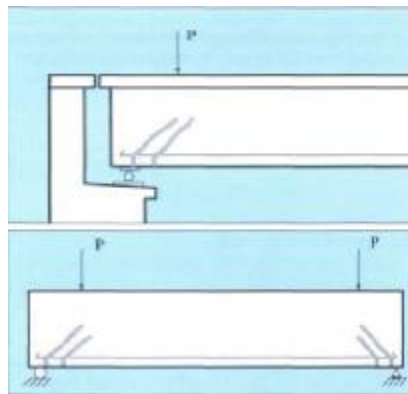

Shear cracking is caused by shear forces and sometimes also by torsional moments, and occurs where the tensile strength of the material has been exceeded, i.e. service conditions - loading. Characteristically, these cracks are inclined at about 45°. They occur near supports, at the ends of haunches, at changes in section or where the quantity of reinforcement has been altered.

BRIDGE INSPECTION

Definitions

TYPES OF DAMAGE

COMBINED FLEXURAL AND SHEAR CRACKING



Combined flexural and shear cracking is caused by a combination of bending moment and shear force or torsional moment. This type of cracking normally develops from ordinary flexural cracks which deviate to become diagonal shear cracks as load increases. Cracking occurs from the tension zone of the structural element towards the compression zone. The cause is service conditions - loading.

FRACTURE



Complete fracture of an element.

Fracture is in most cases due to service conditions - loading or accident - collision.

CHRUSHING



More or less complete destruction of a material due to compressive forces.

Crushing is in most cases caused by service conditions - support movement or accident - collision.

LOOSENING



The cause is loss of attachment, tightening torque or fixity.

Loosening of a fastener is mainly due to service conditions - loading, but it may also become loose due to an accident - collision, for instance when a stone parapet post has been hit by a vehicle.

BRIDGE INSPECTION

Definitions

TYPES OF DAMAGE

DEFORMATION



Loss by an element of its original shape.

Deformation mainly occurs due to service conditions - loading or an accident.

Deformation of machine elements in movable bridges occurs due to plastic flow at the tops of surface profiles when the contact pressure is too high. The cause may be service conditions - loading.

MISALIGNMENT



Loss by an element of its correct position or adjustment.

Misalignment mainly occurs due to service conditions - movement of support.

MOVEMENT

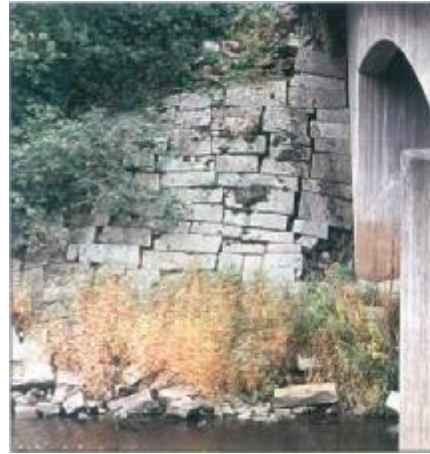

Movement by an element from its original position.

Movement mainly occurs due to service conditions - loading or erosion.

SCRATCH

An elongated depression of small depth.

A scratch can be formed when a foreign object acts on the surface, due to service conditions - abrasion or an accident - collision.

DENT

A single large depression.

The element undergoes plastic deformation due to overload, due to collision of the surface with a foreign object, due to service conditions or accident - collision.

BRIDGE INSPECTION

Definitions

TYPES OF DAMAGE

LEAKAGE



Loss by an element/material of its watertightness.

Leakage is mainly due to service conditions - loading and, in some cases, to environmental action.

Blockage of an element may be caused by service conditions, for instance blockage of a subsurfacing drain, or by lack of maintenance, for instance blockage of a gulley by gravel.

Blockage of a subsurfacing drain may also be due to heating of bitumen in membrane waterproofing on hot days, which causes it to flow.

RUTTING



Uneven wear of surfacing along certain parts of the carriageway.

Rutting occurs only on the wearing course of the bridge deck and is caused by service conditions – wear.

SCOUR



Loss of material from an element.

Scour is caused mainly by service conditions - abrasion or erosion.

HOLE



A hole in the surfacing of a bridge.

A hole is caused by the action of traffic or defective construction.

BLOCKAGE



Loss by an element of its permeability/ability to allow passage of water.

BRIDGE INSPECTION

Definitions

TYPES OF DAMAGE

BLISTERING

CRAZING



Crazing is random cracking in an irregular pattern.

Crazing on surfacing occurs due to the action of traffic or is caused by defective construction.

Crazing on a concrete surface is caused by e.g. defective construction (temperature cracking) or by cracking due to alkali-silica reaction (ASR). ASR is caused by a chemical reaction between siliceous aggregate and soluble alkali compounds in cement. The product of this reaction, an alkali-silica gel, absorbs water and swells. This swelling gives rise to internal pressure which causes the concrete to crack. ASR does not occur until the structure has been in service for several years.

CASTING DEFECT



Caused by faulty placing of concrete.

Casting defect is due to faulty workmanship in placing the concrete, i.e. defective construction/defective maintenance.



Local swelling in the surfacing or a surface layer due to subsurface pressure.

Blistering is mainly caused by service conditions - loading, defective construction or defective maintenance.

LOSS



Fig. Loss of snecks.

Loss of an element/material which was, or ought to have been, originally present on the bridge.

Loss is mainly due to service conditions, for instance the loss of snecks, but may also be due to defective construction.

BRIDGE INSPECTION

Definitions

TYPES OF DAMAGE

DEFECTIVE CONDITION

Apart from actual damage, the structure may be in a defective condition due to other causes. These are "LACK OF DURABILITY" and "LACK OF COMPLIANCE WITH STANDARDS", and are described below.

LACK OF DURABILITY

The service life of a structure may be shortened without there being any actual physical damage. Lack of durability may for instance exist when the concrete is affected by chlorides or carbonation. The process of degradation may have proceeded so far that it has caused actual damage. In such cases the type of primary damage, e.g. corrosion, is to be noted and not lack of durability.

LACK OF COMPLIANCE WITH STANDARDS

At some point, during design, construction or operation, a mistake may have been made when some action was taken and resulted in a departure from current standards such as codes, drawings, specifications etc, for instance in surfacing of excessive thickness. Such mistakes should be thoroughly investigated.

BRIDGE INSPECTION

Definitions

~~TYPES OF DAMAGE ONLY FOR MOVABLE BRIDGES~~

PITTING

Detachment of small flakes of material so that pitting occurs.

Pitting occurs, for instance, in gearing where pressure is excessive - service conditions/loading.

EXCESSIVE PLAY

Excessive play may occur due to the accumulation of deviations in the clearances between several machine elements.

Excessive play occurs if there are faults in the backlash allowances on several gears in a gear train. Excessive play occurs due to wear, service conditions/abrasion.

DEVIATION IN CLEARANCE

The clearance between mechanical components may deviate from the acceptable value.

Deviation in clearance is due to wear, service conditions/abrasion.

UNSERVICEABILITY

Denotes an installation, component, part which is unserviceable.

An element becomes unserviceable due to service conditions or to defective construction.

BRIDGE INSPECTION

Definitions

TERMS USED IN MEASUREMENT

This section describes bridge engineering terms which are used, inter alia, in measuring physical condition.

Stirrup

Reinforcement bent into the shape of a stirrup which resists shear force and torsional moment.

Transverse beam with direct load-bearing function

Transverse beam in direct contact with the bridge deck.

Width (B) of element

Total width of the element at right angles to its principal loadbearing direction.

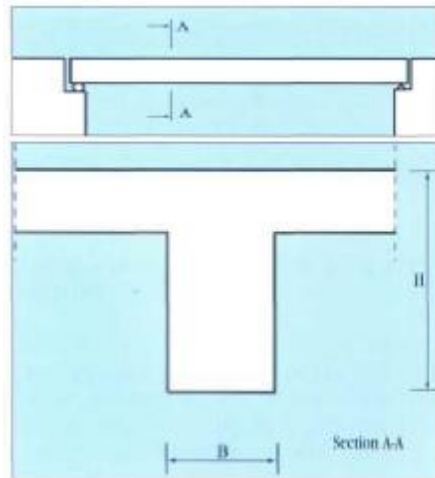

Depth (H) of element

Total depth (thickness) of the element at right angles to its principal loadbearing direction. See also the illustration above.

Length (L) of element

The length of the element in its principal loadbearing direction.

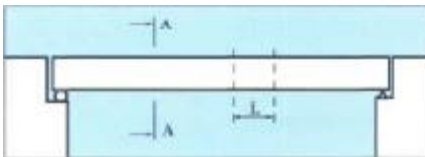

Main reinforcement

Reinforcement parallel to the principal loadbearing direction per element side concerned.

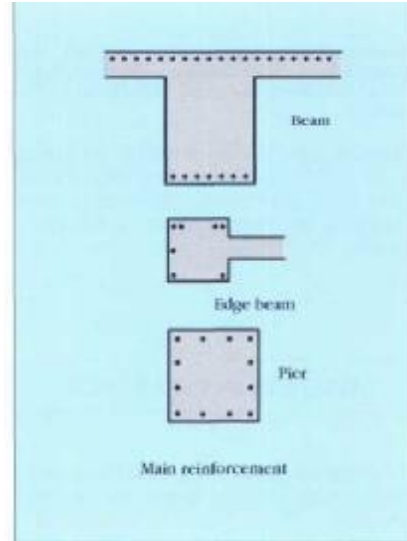

Primary loadbearing direction

The direction in which an element primarily carries its load. See also the examples on pp. 76 and 77.

Load direction

The direction in which a load acts.

Effective width

Assessment of the extent of damage, for instance partial loss of bond or reduction in the area of reinforcement, is usually made for a section whose width is equal to the total width of the element. In some cases, however, the width of the section is to be assumed smaller and put equal to an effective width as set out below.

BRIDGE INSPECTION

Definitions

TERMS USED IN MEASUREMENT

Element	Effective width (m)	
	Primary load-bearing direction	Secondary load-bearing direction
Breast wall	3,0*	3,0*
Ballast wall	3,0*	3,0*
Solid wall	3,0*	3,0*
Wing wall	3,0*	3,0*
Retaining wall	3,0*	3,0*
Culvert	1,0	3,0*
Base slab	3,0*	1,0
Slab (primary loadbearing structure)	B	3,0*
Earth filled arch	II B H	
	0	
Pier (rectangular (B < H))		
Pier (rectangular (B > H))		
Beam (B < H)		
Beam (B > H)		
Column (circular)		
Deck, braced timber deck	1.0	
Deck, decking planks	0.5	
Surfacing (rutting)	0.5	

¹ **But not more than one half the total width of the element.**

See also the examples on pp. 76 and 77

BRIDGE INSPECTION

Definitions

TERMS USED IN MEASUREMENT

Secondary reinforcement

Reinforcement parallel to the secondary loadbearing direction per element side concerned.

Secondary loadbearing direction

Direction perpendicular to the primary loadbearing direction. See also the examples on this and the next page.

Compression zone

That part of the cross section which is in compression.

Fatigue

A large number of load repetitions on a structural element above a certain stress level (fatigue limit) causes the

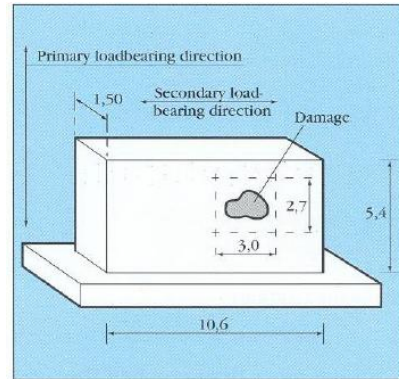

Fig. Example of pier.

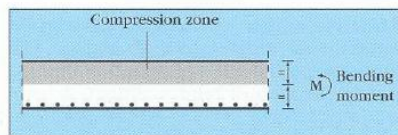
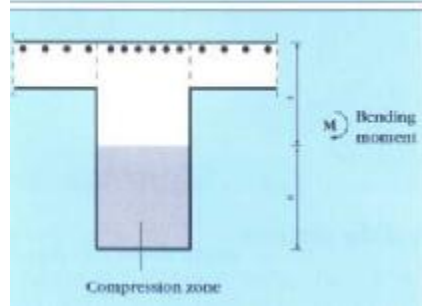
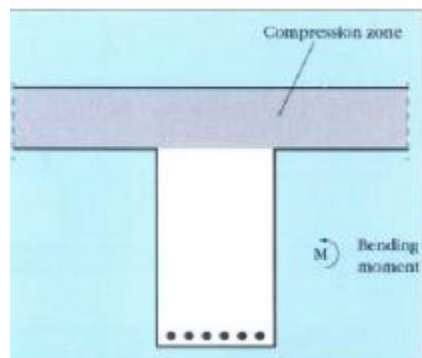

Fig. Examples of compression zone

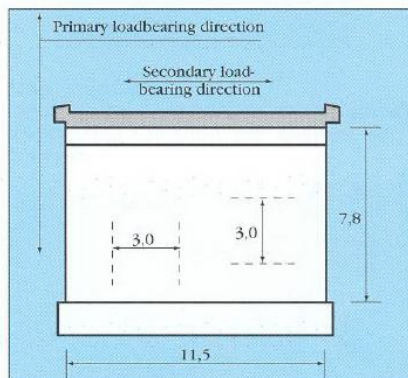

Fig. Example of breast zone.

BRIDGE INSPECTION

Definitions

TERMS USED IN MEASUREMENT

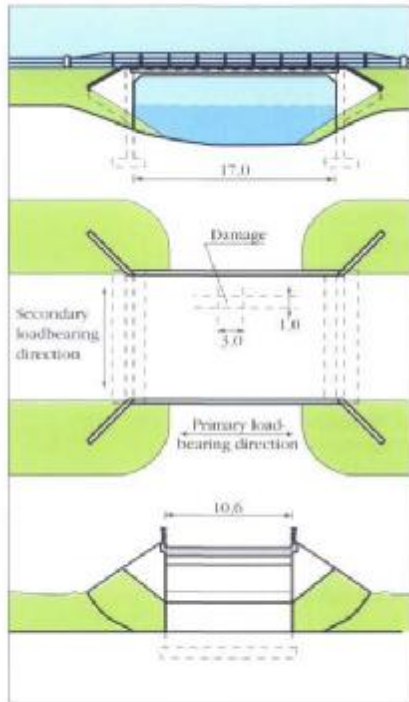

Fig. Example of slab (primary loadbearing element).

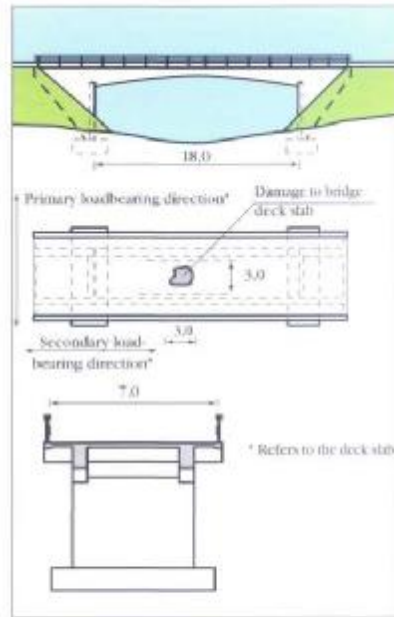

Fig. Example of bridge deck slab.

BRIDGE Inspection procedure

CONTENTS

MAJOR INSPECTION - PLANNING (80 - 81)

Documentation, time, access (80) External contacts and diving (81)

MAJOR INSPECTION - EQUIPMENT (82 - 84) Tools (82). Measuring equipment (82-83) Access equipment (83-84).

MAJOR INSPECTION (85 - 117)

Foundations (85). Slopes and embankment ends (86-87). Supports (87-89). Wing walls and retaining walls (89-90). Bearings (90-91). Main and other loadbearing elements (91-95). Bridge deck slab (96-97). Edge beam (98) Waterproofing (99-100). Surfacing (100-101). Parapet (101-102). Expansion joints (102). Drainage system (102 103) Fenders (103-104). Other details (104) Maintenance contracts (104).

MAJOR INSPECTION - MECHANICAL EQUIPMENT (105 - 110) Visual observations (105-108). Trial runs (108-110).

MAJOR INSPECTION - ELECTRICAL EQUIPMENT (111 - 117) Visual observations (111 117) Trial runs (117)

GENERAL INSPECTION - PLANNING (118)

Documentation (118). Time (118). Access (118). External contacts (118).

GENERAL INSPECTION - EQUIPMENT (119) Equipment (119) Access equipment (119).

GENERAL INSPECTION (120- 123)

Damage which has not been put right (120). New damage (120-123) Maintenance contracts (123).

SPECIAL INSPECTION (124 - 126)

Welding (124). Waterproofing (125 126)

Mechanical and electrical equipment (126).

DOCUMENTATION (127 - 133) WORKING

ENVIRONMENT (134 -135)

BRIDGE INSPECTION

Inspection procedure

MAJOR INSPECTION - PLANNING

A major inspection entails a lot of work which requires good planning if it is to be carried out without any difficulties.

During planning, the following should be taken into consideration and the appropriate action taken.

DOCUMENTATION

The necessary drawings and reports on previous inspections, as well as any reports regarding deviations found at the time of the final inspection, shall be available for the inspection. The performance requirements for the maintenance contract and the contractor's verifications shall also be available for the inspection.

TIME

Choose a suitable time of year in view of e.g. water levels and a suitable time of day in view of e.g. traffic.



If traffic will be affected, a traffic regulation plan shall be drawn up and approved by the road authority.

ACCESS

Equipment

Investigate what equipment and what aids are required for each bridge, for instance the need for a boat, inspection platform, ladders, lighting, etc. Doors, shutters or gates are in most cases locked. Make sure you have a key.

Inspection platform

In choosing an inspection platform, make sure that it is suitable for the bridge concerned. Problems may be caused by a sloping carriageway, piers, suspenders, arches or other structural elements such as tall parapets, protective netting etc.

Find out what space the inspection platform needs with its outriggers set out and whether the bridge can be open to traffic at the same time. Check the loadbearing capacity in regard to the inspection platform. Pay special attention to high outrigger loads.



In most cases, surfaces situated in water must be cleaned before the inspection. The extent of cleaning depends on local conditions. Structures in salt water may be fouled by marine growth, which means that the whole structure must be cleaned.

EXTERNAL CONTACTS

Railway bridges

When bridges over railways, especially those with overhead lines, are to be inspected the track authority must be contacted if there is a risk that inspection will encroach on the risk area for the railway. This may occur when an inspection platform or similar is used. The extent of the risk area can be ascertained from the safety regulations of the Swedish Rail Administration.



Military areas

If the bridge is situated in a protected military area, the authority concerned must be contacted.

If the bridge is situated in a protected military area, the authority concerned must be contacted

Bridge watchman

When a movable bridge is inspected, a bridge watchman must be available.

Other interested parties

In the case of bridges near power stations, dams and similar structures, the interested party must be contacted before the inspection.



DIVING

When inspection involving diving is being planned, this must be done in consultation with a certificated diver.

BRIDGE INSPECTION

Inspection procedure

MAJOR INSPECTION - EQUIPMENT

A lot of equipment is usually needed for an inspection. It may be appropriate to have a special inspection vehicle, for instance a van or trailer.



Apart from the equipment listed below, personal equipment and traffic control equipment will also be needed - see the section "Working environment" on p. 134 - as well as a camera to document damage.

TOOLS

Chipping hammer, hammer and chisel, knife, plumb bob, marking chalk, wood corer, rope.

Electric power unit with cable, electric drill and breaker. In certain places rechargeable equipment will be sufficient.
Torch, portable light, telescope and compass.

MEASURING EQUIPMENT

- Tape measure, folding rule, telescopic bar (5 m), Vernier callipers.
 - Thermometer.
 - Crack width gauge.
- Meter to measure the thickness of coats of paint.
- Cover meter to measure the thickness of concrete cover.
- Ultrasonic instrument or sheet corer to measure the thickness of sheeting and steel members.
- Anemometer to measure wind speed when an inspection platform is used.
- RCT equipment for field tests for chlorides.
- Levelling instrument and staff to check movement of supports etc.
- Equipment for magnetic particle tests or liquid penetrant tests for crack investigation in steel members.
- 3% phenolphthalein solution in a spray bottle to check depth of carbonation.
 - ECP meter for checks on corrosion.

- Equipment for measurement of bottom profiles.

Measuring equipment for movable bridges

- Lamp, stopwatch, hand tools, feeler gauge, caliper gauge, spirit level and steel rule.
- Pressure gauge and flow meter.
- Thermometer.
- Particle meter.
- Universal instrument.
- Clip-on ammeter.
- Megger. Socket tester.
- Optical probes, endoscopes, hand mirrors and fibrescopes for internal inspection.
- Fibre optics and fibrescopes for inspection of gear assemblies.

BRIDGE INSPECTION

Inspection procedure

MAJOR INSPECTION - EQUIPMENT

ACCESS EQUIPMENT

On many bridges, some kind of equipment is needed so that inspection from a distance within arm's reach may be carried out.

Ladders, thigh boots and a boat should always be available.

Some bridges have fixed installations such as inspection trolleys, cradles or hoists which can facilitate inspection.

In many cases, movable equipment such as a hydraulic lift platform, inspection platform or some form of suspended scaffold will also be required..



Underwater inspection

For underwater inspection, inspected and approved diving equipment, special underwater camera, and equipment to clean the surfaces to be inspected, will be required.

In some places a remotely controlled underwater camera can be used.

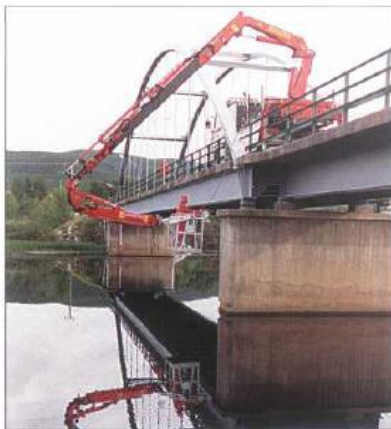

BRIDGE INSPECTION

Inspection procedure

MAJOR INSPECTION - FOUNDATIONS

Before the inspection starts, the reports from previous inspections must be read. A study must also be made of the bridge and its mode of action as well as any reports regarding deviations found at the final inspection.

The inspection must then be carried out systematically so that no parts of the bridge are left out. It may be appropriate to begin with the foundations and to work upwards from there.

On elements of structure in water, the inspection is carried out with the help of divers. At the time of inspection, the surfaces shall be cleaned to such an extent that the purpose of the inspection can be achieved, see the chapter "Inspection requirements", p. 15. Where the depth of water is small (0.5-1.0 m), the inspection can be made in some other way, for instance by using a powerful torch.

Cracks

on the structure shall be documented. The best way of doing this is to mark the beginning and end of the crack, and its width, directly on the structure with marking chalk. Cracks can also be documented on a drawing. In the case of cracks on steel or on welds, a special inspection using nondestructive methods must be made to elucidate the extent, depth and position of cracking.

Cracks

Examine concrete surfaces to see if there are any cracks due to loading. Pay special attention to large structures in which temperature cracking may occur. If cracking is suspected, permanent formwork must be removed from concrete surfaces below water.

Crushing

See if the structure has crushing damage caused by vehicle/ship impact.

Rotting

There must be no rotting on timber piles or permanent timber sheet piles, timber grillages etc.

FOUNDATIONS

Weathering

Check whether there is any damage due to weathering. On structures in water, the splash zone is specially exposed.

Corrosion

There must be no exposed reinforcement attacked by corrosion. Cracks and rust marks on concrete may indicate corroded reinforcement and shall be further investigated by exposing the reinforcement.

When chloride penetration into concrete is suspected, the required measurements must be made. This applies mainly to structures in a marine environment, especially to structures cast below water.

On sheet piling, corrosion can be present especially in the splash zone or at ground level.

BRIDGE INSPECTION

Inspection procedure

MAJOR INSPECTION - SLOPES AND EMBANKMENT ENDS

Timber which appears sound on the outside may have extensive rotting on the inside and shall therefore be inspected by tapping.

Pay special attention to creosote treated timber. If uncertain, take cores. Timber structures in foundations must at all times be situated below water level.

All timber in salt water

must also be checked for attack by marine borers.

Movement

Check that stones in box caissons have not moved.



Fig. Blocked watercourse.



Fig. Scour.

Scour

Watercourses shall not be blocked but shall allow free passage of water. Check revetments, fill etc to ensure that scour has not occurred below base slabs etc. This applies in particular to bridges where water flow is powerful.

If it is suspected that the shape of the bottom has altered, take measurements to ascertain bottom profiles.

Rubble and plant growth

may divert watercourses in such a direction that scour occurs.

SLOPES AND EMBANKMENT ENDS



Movement

Check that the fill in front of the wing wall is the correct height and see whether there is any movement in stone cladding or paving slabs.



If the load increases

on the road embankment or if the foundations are bad, slopes and embankment ends may be pushed outwards and downwards so that there is a difference in level between the bridge and the embankment. This may give rise to undesirable impact effects in the bridge structure.

BRIDGE INSPECTION

Inspection procedure

MAJOR INSPECTION - SLOPES AND EMBANKMENT ENDS / SUPPORTS



Cracks and rust discoloration on the concrete may indicate corrosion of reinforcement and shall be subjected to closer examination by exposing the reinforcement. Details which are particularly exposed to weathering and corrosion are bearing seats with grout beds below leaky movement joints, piers and abutments exposed to chloride and water spray from road traffic, and structures in a marine environment.

Scour

Check for scour due to water from bridge and the embankment.

SUPPORTS



Fig. Weathering of concrete on the abutment.

Weathering/Corrosion

Check that there is no damage to concrete due to weathering. There must be no exposed reinforcement or corrosion. Check also the top of the ballast wall which is sometimes damaged by weathering.



Fig. Weathered concrete on bearing seat and breast wall.

BRIDGE INSPECTION

Inspection procedure

MAJOR INSPECTION - ABUTMENTS AND PIERS



Fig. Pier with corroded reinforcement.

If it is suspected that carbonation of concrete has occurred or it contains chlorides, the necessary measurements are to be made.

In the case of underwater inspection, the surfaces shall be cleaned from vegetation and similar. The damaged portions shall be accurately surveyed.

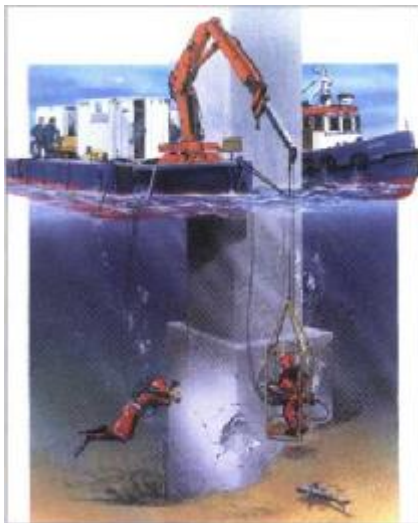

Cracking

Examine concrete surfaces for cracks due to loading.

Vertical tension cracks on breast walls and ballast walls are common and are often caused by shrinkage. In ballast walls there may also be horizontal cracks near the bearing seat, chiefly due to displacement of support. Check steel supports for cracks, especially on flanges and around welds.



Fig. Tension crack on abutment breast wall.

Spalling/Crushing



The contact between the superstructure and the abutment on a bridge with an expansion joint may cause spalling on the ballast wall.

Check whether the structure has crushing damage due to impact by vehicles/ships.

MAJOR INSPECTION - SUPPORTS/WING & RETAINING WALLS

Loosening

Bolts and rivets shall not be loose or ineffective. Whether or not a bolt/rivet is loose can be found most easily by checking whether the paint around the bolt/rivet has cracked.

Check by tapping that the edge protection on the ballast wall is not loose.

On a stone support, check that stones are not loose, displaced or missing. Be particularly observant in flowing water. Each suspected movement should be surveyed and compared with any previous measurements.

On stone supports, cracking may occur due to uneven contact pressure.

Joint sealant shall be intact, and concrete placed over formwork ties shall not be loose or missing.



Fig. Movement in pier.

Movement

Suspected movements on abutments and piers shall be checked against drawings and with the help of the plumbing pegs and the levelling pegs on the edge beams. Damage can often be traced to movement of the foundations.



Fig. Movement in abutment.

WING WALLS AND RETAINING WALLS

Edge beams on wing walls and retaining walls are classified as edge beams.

Weathering/Corrosion

Check if there is any damage to concrete due to weathering. There shall be no exposed reinforcement or corrosion. Cracks and rust discoloration on the concrete may indicate corrosion of reinforcement and shall be subjected to closer examination by exposing the reinforcement.

If it is suspected that concrete has been carbonated or it contains chlorides, the necessary measurements are to be made.

Spalling

chiefly occurs at the joint between the bridge/retaining wall and wing wall.

Cracking

On splayed wing walls it is usual for tension cracks to occur at the top of the wall and near construction joints.



On retaining walls there are often vertical tension cracks where concreting lifts had been wide.

In dry stone walls cracks may occur due to uneven contact pressure.

Loosening

Stones shall not be loose, displaced or missing.



Fig. Weathered mortar.

Any joint sealant shall be intact, and concrete placed over formwork ties shall not be loose or missing.

Movements

Check that freestanding retaining walls have not been displaced/settled in relation to the adjoining structure, e.g. a wing wall.

Check that wing walls in a precast structure are not deformed.

BEARINGS

Corrosion

Examine steel components such as rollers, bearing plates, sliding layers, segmental bearings, anchor bolts etc for corrosion. Make a special check on high strength bearings to ensure that there is no corrosion.



Fig. Spalli

Concrete hinges shall be checked for corrosion, weathering and spalling.



Fig. Crack on bearing.

Cracking

Check that steel and elastomeric bearings are free from cracking.

Loosening

Check that the fasteners holding the bearing are fully effective, and that the bearing is seated firmly and does not move due to insufficient bearing pressure.

Check that protective sleeves perform their function.

Misalignment

Check also that the alignment of the bearing is correct in view of the prevailing temperature. If alignment is wrong, check if there has been movement of the support.

BRIDGE INSPECTION

Inspection procedure

MAJOR INSPECTION - - BEARINGS/LOADBEARING STRUCTURE



Fig. Misaligned bearing.

Bearings which shall be greased shall be checked for this.

Abnormal deformation, plastic flow of steel details may limit movement of the bearing.

Check that the rollers are in full contact with the bearing plates along their entire length.

MAIN BEARERS AND OTHER LOADBEARING ELEMENTS

The deck slab on slab bridges and slab frame bridges is classified as part of the primary loadbearing structure. Its inspection is however described under Deck slab.

Box girder structures must also be inspected on the inside.

LOADBEARING ELEMENTS OF CONCRETE

Leaching

Check for leaching near prestressing anchorages, especially at the ends of the bridge.

Weathering/Corrosion

Check for weathering and spalling on concrete structures.

There shall be no exposed reinforcement or corrosion.

Cracking in concrete may indicate reinforcement corrosion and shall be subjected to closer study by exposing the reinforcement.



If it is suspected that concrete has been carbonated or contains chlorides, the necessary measurements shall be made.

Casting defects

If it is suspected that there are internal casting defects in the concrete or that prestressing cables have been unsatisfactorily grouted, a special inspection is to be made.

Appropriate test methods are described in the chapter "Measurement, sampling", section Concrete, p. 147.



Cracking

Investigate loadbearing structural elements of concrete for cracks due to loading. Check particularly in box girders whether there is any cracking on the bottom flange or the lower part of the web.

Note that prestressed structures shall not normally have any cracking.

BRIDGE INSPECTION

Inspection procedure

MAJOR INSPECTION - - LOADBEARING ELEMENTS

Crushing

Check whether there is any damage on the concrete structure due to impact by vehicles; this is most common on ties and on the soffit of beams above the carriageway.

Check whether there is any displacement between units in precast bridges.



Sensitive details are bolted and riveted connections, supports and places where girders are in contact with the concrete structure, and on a steel bowstring bridge the junction between the arch rib and the tie.

LOADBEARING ELEMENTS OF STEEL

Where this is considered necessary, bridges with a steel superstructure should be observed both with and without traffic. This is appropriate, for instance, when large oscillations occur in the bridge or there are abnormal movements at the supports.



Fig. Dehumidification apparatus inside a steel box girder

A check is to be made inside steel box girders whether there is any condensation which increases the risk of corrosion.

Check whether there is any crevice corrosion in bolted and riveted connections. If crevice corrosion is suspected, the thickness is to be checked by ultrasonics so that the reduction in thickness due to rusting can be assessed.

Corrosion

Check the surface finish on steel structures for flaking, blistering and corrosion. Impurities, sand, bird droppings etc can bind moisture and greatly accelerate corrosion.



Fig. Corrosion of suspender.

BRIDGE INSPECTION

Inspection procedure

MAJOR INSPECTION - - LOADBEARING ELEMENTS

Special inspection is to be made of steel culverts at the water line where corrosion is most common. It is best to carry out the inspection at low water. Where there is pitting, the remaining sheet thickness is to be determined, either by taking a sample or by ultrasonics. When corrosion has penetrated right through a steel culvert, there is a risk that the fill around the culvert will be washed away.

This means that the structure loses its loadbearing capacity.

Check also that the culvert is not deformed.



Cracking

Check steel structures for cracking and delamination, especially on flanges and around welds. In riveted structures, for instance trusses, cracks may initiate from the rivet hole.

Other exposed places are suspender attachments on ties and the arch rib. Bridges containing welded plate girders with flared flanges are to be inspected with special care for cracks at the weld along the web over the entire length of the bridge and on both sides. A special inspection is to be made if necessary.

Check that no welding or cutting has been performed on older rolled girders. If the girders were made before 1952, the material is basic Bessemer steel. In this steel, cracks or fracture easily occur when it is welded or cut.

Any crack found must be immediately treated. The first action to be taken is to stop the crack by drilling a hole at its end.

Loosening

Check that no bolts or rivets are missing or sheared off. Nor shall bolts or rivets be loose or ineffective. A loose bolt/rivet can be detected most easily by checking if the paint around it has cracked.

Movement

Check for movement in the connection. If movement (slip) is found in high strength friction grip connections, check the preloading of the bolts.

Check whether suspenders are abnormally tight or loose by comparing their 'ring' in response to a light tap. One good way of checking is to watch the bridge under heavy traffic and see whether any suspender oscillates too much.

A check is also to be made whether the suspender attachment in a suspension bridge has moved along the main cable.



Fig. Contact with the ballast wall may cause deformation in a steel girder.

Deformation

Check flanges, web plates, tie bars and struts, suspenders and ties for any kind of damage, buckling or deflection.

Check also for abnormal deflection of the structure. This can be studied most easily by following the alignment of the parapet.



Suspender attachments may for instance be deformed due to impact by snow clearing equipment.

**LOADBEARING ELEMENTS OF
STONE**



On the intrados and side walls of earth filled arch bridges, check if any stones are loose, missing or displaced. Check if there is any cracking due to uneven contact pressure. Pay special attention to damage on flat stone arches. When movement has occurred, mark the positions of the stones to facilitate future observations.

Mortar in the joints shall be intact. Check if there is any settlement in the carriageway above the arch. This indicates movement of stones in the arch.

Fig. Cracked stones on the intrados.



Fig. Cracked stones on the intrados.



Fig. Movement in an arch.

MAJOR INSPECTION - - DECK SLAB

BRIDGE DECK SLAB

The bridge deck slab on a slab bridge and slab frame bridge is the primary loadbearing element, but for inspection purposes it is dealt with together with other types of deck slab.

Fig. Leaching.

SLAB OF CONCRETE



Fig. Leaching.

Leaching/Weathering

Check if there is any leaching or weathering on the slab soffit.

If there is efflorescence (leaching), this may indicate leakage through the waterproofing and damage to the top of the slab. In such cases, a special inspection is to be made in accordance with the chapter "Measurement, Sampling" in the section "Concrete surfaces below the waterproofing" on p. 150. Weathering may also occur on concrete topping cast directly on the structural concrete.



Corrosion

There shall be no exposed reinforcement or corrosion. Cracks and rust discoloration on the concrete may indicate corrosion of reinforcement

and shall be subjected to closer examination by exposing the reinforcement.

If it is suspected that the concrete has been carbonated, the necessary measurements are to be made.

Casting defects

If it is suspected that there are internal casting defects in the concrete or that prestressing cables have been unsatisfactorily grouted, a special inspection is to be made.

Appropriate test methods are described in the chapter "Measurement, Sampling", the section Concrete, on p. 148.

Cracking

Check the deck slab also for cracking due to loading. On steel girder bridges with a concrete deck slab, there are often tension cracks across the slab. In continuous slab bridges there are sometimes flexural cracks at the top of the slab over the supports. Settlement cracks may occur along reinforcing bars if the concrete cover is too small.



Fig. Cracking in topping concrete.

Cracking shall not occur in topping concrete cast directly on the structural concrete, since water penetrating through the cracks can easily reach the reinforcement.

Crushing

Check if the slab has any damage due to impact by vehicles. In a simply supported slab there may be crushing at the end of the slab due to tight contact with the ballast wall as a result of support movements.

Loosening

Check by tapping that the edge protection at the ends is firmly seated.

Rutting

Check on bridges with topping cast directly on the structural concrete if there is any rutting.

BRIDGE INSPECTION

Inspection procedure

MAJOR INSPECTION - - DECK SLAB

STEEL DECK

Check steel decks for corrosion. Decks of corrugated sheeting may be attacked by corrosion at the top of the deck, without any visible damage on the underside, due to ponding at low points.

If there are gaps between decking planks/aluminium sections, this is probably due to loosening of the anchor bolts.

TIMBER DECK



Check a timber deck for the quality of timber and attachment of decking planks and crossbeams, and to ensure that nails have not begun to move upwards; this is due to rotting or poor bedding. Rotting in a braced timber deck and the crossbeams is checked most easily by taking cores. Check also that timber crossbeams and wedges are in proper contact with the steel girders.

MAJOR INSPECTION - - EDGE BEAM

EDGE BEAM

Weathering

Check for damage due to weathering or spalling.



Fig. Edge beam on wing wall.



Corrosion

There shall be no exposed reinforcement or corrosion. Cracks and rust discoloration on the concrete may indicate corrosion of reinforcement and shall be subjected to closer examination by exposing the reinforcement. These cracks are mostly found on the soffit of the edge beam.

If it is suspected that the concrete has been carbonated or contains chlorides,

the necessary measurements are to be made.

Cracking

may occur at the parapet posts, both around the embedment site and across the edge beam. In slab bridges with intermediate supports, there are sometimes flexural cracks in the edge beam over the support.

Loosening

Check that the edge protection is seated firmly and is not corroded. Check that the levelling pegs are still in place.

WATERPROOFING



The first indication of leakage through the waterproofing is cracking on the soffit of the deck slab and, if the bridge has water vapour outlets, discharge of water from these. After a short time efflorescence occurs around the leak.

In the case of efflorescence near cracks and water vapour outlets, the

presence of a leak cannot be determined with certainty unless the soffit of the slab is damp around these, since efflorescence may have occurred before the waterproofing was laid.

A damp patch on the soffit of the deck slab, where there is no cracking or a water vapour outlet, is not usually detected until long after leakage had started. Leaks of this kind can be detected by the presence of damp patches with or without efflorescence, differences in colour, rust or frost splitting and crazing, or a combination of these.

Prestressed concrete structures

Pay special attention to prestressed concrete structures and to bridges with waterproofing laid several years ago. The same applies to bridges with older types of waterproofing such as coats of asphalt or epoxy.

If there is crazing or cracking in the surfacing, in most cases this indicates weathering of the concrete

protection course or damaged/blocked drainage channels. In the long run, these may give rise to damage in the waterproofing.



Blistering on the surfacing may indicate that there is blistering in the waterproofing also.

If it is suspected that there is leakage or damage to the concrete protection course, a special inspection of the waterproofing must be made.

Measurements can be made with pulse radar to locate leaking waterproofing or defective subsurfacing drains.

Flaking

The epoxy seal on the inside of the edge beam is to be inspected with regard to flaking. Flaking may indicate that water penetrates into the concrete between the edge beam and the surfacing, and has caused damage.

MAJOR INSPECTION - - SURFACING

SURFACING

With regard to damage to topping concrete cast directly on top of the structural concrete, see the section Deck Slab.



Weathering

Check for weathering on concrete surfacings.

Cracking

All surfacing should be free from cracking and as watertight as possible to prevent penetration of water.

Make a special check that there are no cracks (gaps) near edge beams expansion joints, gulleys and the construction joints on bridges with concrete surfacing. These should contain joint sealant, and this shall have good adhesion to the surrounding materials.

On slender structures, particularly in the north of Sweden, cracking may occur due to large temperature variations. If there are cracks, the waterproofing should also be checked.

There may be transverse cracks between the road embankment and the bridge. These may indicate cavities or movements of the embankment.



Rutting/Blistering

Check if there is any rutting.

Make sure that there is no blistering on mastic asphalt surfacings, since this can give rise to durability and road safety problems.

Crazing/Holes

If there is crazing, in most cases this indicates that the concrete protection course is weathered and in poor condition. In the long run, this may give rise to holes and the risk of damage to the waterproofing, as well as to undesirable impact effects on the structure. If the thickness of the surfacing is greater than shown on the most recent drawing, this should be investigated to ensure that the increased weight has no effect on the permitted traffic load of the bridge.



PARAPET



Corrosion

Inspect steel parapets and especially the posts where they are cast into the edge beam, since it is here that steel is often attacked by corrosion. Damage can be aggravated by inadequate cleaning. When the post is corroded, damage is sometimes more serious below the level of the concrete, and it may therefore be necessary to remove part of the surround to assess the severity of corrosion. Check also on the safety arrangements above electric railways.

It may be appropriate to measure the zinc thickness so that the remaining service life of the surface treatment may be judged.

Reinforcement in concrete parapet posts may also be attacked by corrosion.

Vertical cracks in the concrete are an indication of corroded reinforcement.

Deformation

It is usual for bridge parapets to be hit by vehicles. This causes damage such as spalling, cracking, fracture, crushing and deformation. The types of damage are to be assessed in each individual case.

Check that parts of the parapet are not loose.



Deformed parapet

Note the vertical and horizontal geometry of the road and bridge parapet. Check that joints allow movement.

Telecommunication or electric cables should not be laid inside the deflector rail.

EXPANSION JOINT

Check the steel components for corrosion.

Loosening

Check by tapping that the fasteners are effective. Insufficient bedding concrete may also cause a difference in sound.

A difference in sound on joints comprising springs may indicate that these are broken. Check that there is no cracking/fracture in cover plates or bearers.

Check that the sealing profile or joint sealant has not become loose. If the sealant around the anchor bolts has become detached, this may indicate that fasteners are loose.



Leakage

Check that sealing profiles do not leak and that they have not been blocked by surfacing.

Check against the drawing that the joint opening is correct in view of the prevailing temperature. Opening of the wrong dimension may indicate movement of support.

Note that the level of the adjoining surfacing should be 5 mm above the expansion joint, otherwise damage due to impact by vehicles may easily occur in the winter.

BRIDGE INSPECTION

Inspection procedure

MAJOR INSPECTION - - DRAINAGE

DRAINAGE SYSTEM

Corrosion

Check for corrosion of gulleys, downpipes etc. Check also that the downpipes are undamaged, properly fastened and not blocked by gravel. Pay special attention to embedded downpipes.



Blockage

Check the performance of the subsurfacing drains. Owing to defective workmanship, these are often blocked by bitumen from the waterproofing or by epoxy-modified tar from the drainage channels. It is best to check after rain.

In the long run, blocked subsurfacing drains may damage the deck slab, especially at low points. Stone arch bridges of the closed spandrel type also often have drains in the arch, and it is important to check these.

Drainage channels are difficult to inspect, but longitudinal cracks in the surfacing may be an indication that they are blocked.

It is important to make sure that no drain discharges above structures situated below such as bearing seats, steel girders, base plates etc, or inside box structures. A lot of damage due to weathering is caused by this.

Also bear in mind that a drain which discharges above a slope or embankment end may cause future problems due to scour.

Check that there is no ponding on the bridge due to wrongly sited gulleys or defective workmanship in applying resurfacing.

FENDERING

Weathering/Corrosion

Check that there is no damage to concrete due to weathering. There shall be no exposed reinforcement or corrosion. Cracks and rust discoloration on the concrete may indicate corrosion of reinforcement and shall be subjected to closer examination by exposing the reinforcement. If it is suspected that the concrete has been carbonated or contains chlorides, the necessary measurements are to be made.

Rotting

Check that timber piles, planks for walkways and fenders are not attacked by rot. Timber which appears sound on the surface may have extensive rotting on the inside. Piles must therefore be examined by tapping. In case of uncertainty cores should be taken.



All timber in salt water

should also be checked for fouling by marine borers.

Cracking

Check for cracking. Any cracks found may be either tension cracks or cracks formed during or immediately after casting, such as plastic shrinkage cracks.

Crushing

Check for crushing damage on concrete structures due to impact by ships.

Deformation

Check whether deflectors are deformed due to impact by ships.

Loosening

Check that no nails, bolts or other fasteners are loose.

Scouring

Check revetments and fill for scour near piles, dolphins etc. If it is suspected that the bottom formation has changed, carry out measurements to determine bottom profiles.

OTHER DETAILS

Aesthetic details

On structural elements and components there are aesthetic details which must also be inspected.

Check, for instance:

that quarry tiles are not loose and that grout has not weathered,
that coats of paint have not flaked off or blistered, and that there is no chalking.

MAINTENANCE CONTRACTS

Check at the time of the inspection that the performance requirements specified in the maintenance contract have been complied with. Any deviations shall be measured up and documented. Use the methods of measurement set out in "Measurement and condition assessment of bridges", Publication No 1996-038 (E).

MAJOR INSPECTION - - MECHANICAL EQUIPMENT

The inspection is to be carried out in two stages,

VISUAL OBSERVATIONS**TRIAL RUNS.****VISUAL OBSERVATIONS****Gear drives**

Does the gearing engage correctly and is wear normal? Are there incipient cracks at the roots of the teeth? Enclosed gearing should be examined carefully for leakage of lubricant. This applies in particular to small gear assemblies which are emptied rapidly without any external signs. Gearing always generates a certain amount of friction heat. When a gear is getting worn, temperature rises. Gearing temperature also increases due to over-lubrication and overload. The temperature of gearing should therefore be placed under observation. Any change in gearing usually also causes a change in gear noise. Measurements of sound level can then be made. Defective gearing can also give rise to a different vibration pattern. Observations with vibration measurements can then be made. Flank clearance is a measure of wear. Measurements with feeler gauges give approximate values. If more accurate readings are required, dial gauges can be used. The component must be demounted for this to be done.

Shafts

Check that shafts are straight and that shafts at the fillets or otherwise are free from surface cracks. Are shafts correctly mounted, and are shafts in an interconnected system parallel?

Bearings

When a sliding bearing is getting worn, bearing play increases, and this is in many cases a good indication of the condition of the bearing. Bearing play can be measured in different ways, for instance with a dial gauge, a lead impression in combination with a micrometer, or with a feeler gauge. Check the seal. A good seal which prevents ingress of impurities is very important for all types of bearings. Play in roller bearings cannot usually be checked reliably since these bearings are made with

very small tolerances. The material in a roller bearing is attacked very easily by water. In a damp environment it is therefore appropriate to investigate if the bearing has been attacked by rust. If this is the case, the bearing should be replaced and some other lubricant of better resistance and protective capacity should be used.

Joints with force fit or shrink fit

If these joints become loose, the cause may be that one of the components has cracked or expanded. A faultfree joint of this type is very homogeneous and emits a ring when struck with a hammer. Cracked or loose joints emit no ring.

Chains and chain wheels

Wear at the pins is usually the best indication of the condition of a roller chain. One simple and reliable way of noting the wear at the pins is to measure the length of the stretched out chain over e.g. ten links and to compare this with previous measurements. Make sure that the tension is correct.

Belt drives

It is important for vee belts to be correctly tensioned. A slack belt slips, twists or gallops. A belt that is too tight puts too much load on the pulley bearings and also increases wear of the vee belts.

Couplings

Shaft couplings are important elements which are found on many bridges. Couplings which are worn or loose can cause serious problems, and they should therefore be checked carefully.

There are different types of couplings. The most common type is the flexible rubber disc coupling in which rubber discs are the damping elements.

The rubber discs are worn radially and should be replaced when the play exceeds 1 mm. The coupling continues to work when the discs are worn, but the impact forces which are generated can damage the connected elements.

Another type of coupling which is often used is the claw coupling which, in the axially displaceable version, is used for manual operation. When the play is greater than 1.5 mm, the coupling should be replaced.

Brakes

Slip is a usual fault. The cause may be wear of the brake lining or the presence of some deposit such as oil on the drum. The time for the brake to act is

then longer than normal.

Slip may also be due to excessive play between the drum and the lining, or wear and misalignment of the linkage system.

Steel wire ropes

Pay special attention to those parts of the rope which are subject to wear. Important items to check are whether any wires are broken, or if there is deformation or rusting. Wire breakage usually occurs towards the end of the service life of the rope and is a result of flexural fatigue and wear.

Deformations are in most cases a result of mechanical action on the rope. Rusting, whether on the outside or inside, implies that the rope has not been oiled as required.

Internal rusting occurs in certain working environments and results from the use of too little lubricant, or the wrong lubricant.

When checking steel wire ropes, special attention should be paid to the following:

- that no strand is loose on the rope,
- that the external wires of strands are not loose,
- that the strands, due to overload or fatigue, have not become entangled, so that they are no longer clearly separated from one another,
- that broken wires from the inside of the rope cannot be seen between the strands,
- that the diameter of the rope is not less than the nominal value,
- that no rust can be seen when the rope is twisted apart,
- that the rope has not been exposed to extreme thermal action which has caused reduction in strength,
- that bedding down of the rope does not exceed permitted values.

Rope drums, rope pulleys

The cause of premature wear and in some cases the cause of direct damage to the rope may be:

- the diameter of the drum is too small,
- the fleet angle is too large,
- there are several layers of rope.

Balancing pulleys can give rise to torsional stresses in the rope, which in turn results in wire fracture.

Pivots, wedge blocks, bearer wheels, balance wheels and wheel tracks for swing bridges

If possible, the cover plates over the pivot bearing should be removed and an inspection made.

Any play in the wedge blocks is to be measured with a feeler gauge. Note that the play may vary depending on air temperature and wind direction. The play at the bearer wheel and balance wheel should also be measured. Compare this with the values on the drawing, which should be regarded only as recommended values. The flatness of the wheel track is to be checked if deviations from planarity are found.

Roller segments and roller tracks for bascule bridges



Fig. Measuring the width of the roller track



Fig. Measuring the width of the roller segment.

If there is any plastic flow, this should be measured. The best way to do this is to measure the width of the roller segment-roller track and to compare this with the nominal value. If plastic flow is extensive, check the flank and bottom clearance on gear teeth.

The clearance is to be measured with a feeler gauge. If the flank and bottom clearance is equal to zero, the teeth transmit vertical forces for which they are not designed. Immediate action must then be taken



Fig. Measurement of flank clearance.



Fig. Measurement of bottom clearance.

Nose bearings and bedding grout

On all types of bridge, the nose bearings must be checked. These may be worn and the anchor bolts may be defective. Bedding grout may also be unsatisfactory. Check that there is proper contact in the road traffic position. In the case of bearing pads which are placed at the tails of the main girders in double leaf bascule bridges, check that there is proper contact in the road traffic position.

There must be no movement when heavy vehicles pass. If necessary, adjust the bearings.

Hydraulically operated bridges

On hydraulically operated bridges, check that there are no leaks at the seals on piston rods, pumps, hydraulic motors, valves or pipe couplings. If there is leakage, assess when the seal must be replaced.

Pipes and valves should also be checked for vibration. Vibration may occur along the pipe and may be difficult to detect. Copper pipe exposed to vibration may become brittle due to

cold working. In a pipe system, the weak points are the bends.

The undersides of pipes are usually exposed to more wear than their top sides. Examine the chromium plating on piston rods and see if there are any cracks, marks or abnormal wear.



Fig. Measurement of chromium plating.

If any damage is detected, it should be immediately repaired since there is a risk of damage to the piston rod seal. Piston rods are also made of stainless steel.

TRIAL RUNS



Control panel

The instruments and the function of the indicator lights on the control panel are checked in the control cab during the trial run.

Time of operation, working current/pressure for ordinary machinery and the standby plant are to be noted. Check that these values agree with those in the operating instructions. If there is a large difference, the reason for this must be investigated.

Machinery

When the machinery is in operation, check acceleration and retardation and whether there are any unallowable deformations in machine elements.

MAJOR INSPECTION - - MECHANICAL EQUIPMENT

Check that the anchor bolts and other fasteners are properly tightened. Listen to the motor/motors to find if there is any abnormal noise.

Gear drives

Check that the gear wheels do not move radially or axially on the key/keys. Also that the flanks are in contact over the whole width of the tooth and that the mesh is correct.

Ropes

Check the ropes as during visual observations. See p. 106.

Drums, pulleys

Are there cracks, are the pulleys worn, are there marks on the grooves? Is rotation normal? Check the bearings.

Brakes

Check the performance of the brakes.

Are brake straps worn? What does the brake drum look like? Is it scratched, oily?

Is the linkage system properly adjusted?

Pivots, wedge blocks, bearer wheels, balance wheels and wheel track for swing bridges

Check pivot bearings. Listen for any abnormal noise.

Are the bearer wheels in contact with the wheel track? If any wheel is not in contact, check that the track is planar. Do the balance wheels rotate (this may vary depending on wind conditions). Are these correctly adjusted?

Check the function of the bearings on all wheels.

What do the wedge blocks look like? Are the surfaces rough?

Hydraulic ram machinery, nose bearings for swing bridges

Check that these are screwed or wedged to the correct level and that the play at the rams is adequate and uniformly distributed.

Check that the rams work symmetrically and that their operation warrants no adverse comments.

Hydraulic ram for bascule bridges

Check the movement pattern of the rams carefully. Do they work symmetrically? Check that the clearance at the bearing on the main girders is adequate. Check that the rams work so as to ensure that the bridge is mechanically locked in the road traffic position.

Roller segments and roller tracks for bascule bridges

Check that the roller segments have a normal alignment when they roll on the track. If alignment is wrong, the teeth on the segment may begin to "climb"; this is shown by wear on the inside and outside of mating teeth.

Is the roller track free from dirt and rubble? If there has been plastic flow in the material, check that the teeth do not reach to the bottom of the tooth gaps. Is there sufficient space left between the teeth and the roller track?

Bear in mind that if there is no space left, the bolts for the rack are exposed to higher stresses than what they are intended for. Check also the planarity of the roller track.

Check further that the teeth are unbroken.

Centering arrangement

Does the block engage with the recess? Does damping work both vertically and horizontally?

Check whether the block is damaged in any way?

Nose locks for bascule bridges (double leaf bascule bridges)

Do the blocks enter their counterparts without difficulty? Read the current consumption/hydraulic pressure. Check whether the bearing has scratches or cracks. Check the other details.

If play is large, measure the diameters of the lock and bearing. If play is too large, more than 2 mm, the block should be replaced.

Hydraulically operated bridge

Checks are to be made as for visual observations. See p. 108.

Manual operation

Check that manual operation works properly.

Balancing of bascule bridge

On a bridge with mechanical machinery, balancing can be performed by raising the bridge to about 45° and then carefully disengaging the brake.

The brake drum shall then tend to rotate in the direction which makes the bridge go down.

Repeat the procedure at about 5°. If movement opposite to the above is obtained, the bridge must be rebalanced. The front heaviness which the bridge shall have is set out in the design calculations. NOTE that in each trial run the leaf must be braked as soon as the direction of the brake drum is correct.

On a bridge with hydraulic machinery

the bridge must be weighed at the nose bearings (single leaf) or at the tail bearings (double leaf). The load on the bearings is set out in the calculations.

Balancing of swing bridge

Swing bridges with counterweights are the bobtail type. Check the balancing by weighing at the nose bearings and at the jacks. The load is set out in the calculations.

Balanced cantilever type bridges may also have counterweights.

Balancing of lift bridge

Balancing is to be carried out in accordance with special instructions.

Road barriers, machinery

Check the function of the machinery and manual operation.

Other details

Measure the gap between the fixed and movable part of the bridge. Take account of temperature changes. Is the clearance too small, can the bridge jam?

BRIDGE INSPECTION

Inspection procedure

MAJOR INSPECTION - - ELECTRICAL EQUIPMENT

The inspection is to be carried out in two stages,

VISUAL OBSERVATIONS

TRIAL RUNS.

VISUAL OBSERVATIONS

HYDRAULIC UNIT

Check

- that the position indicators or LED on solenoid valves work,
- that the detectors for level, pressure and heat work,
- that there are no oil leaks on electrical equipment or cables.

ELECTRICAL COMPONENTS

Check

- that no cables have been damaged by being trapped.

MOTORS

Check

- that slip rings/commutators are not burned and that the brushes are in uniform contact. The space shall be free from dust from the brushes. There must be no sparking during operation.

- that the brushes are not worn more than is commensurate with full contact along the whole brush holder.

Insulation tests should be performed if the motors are above a certain age. The insulation level shall be better than 1.4 Mohm.

- that the insulation on the windings is not damaged.

RESISTORS

Check

- that the resistor chamber or coils are not damaged,
- that there is no overheating. Is there discoloration on resistor

elements or cover plates?

- that resistor fingers are not deformed. Are there grooves due to partial short circuiting or have they become welded together?

- that mica insulation on fingers has not been displaced. Porcelain insulators and tubes shall be undamaged.

- that resistors are marked so that function and appropriate operation cannot be mixed up.

Measure

- the resistances of secondary resistors from the brush gear of the motor and compare with documentation. Measure for each controller stage.

- the times for connecting the different controller stages.

Connections

Check

- that connections are tight. See if there are any traces due to overheating, discoloration of connections due to overheating and/or material changes (alteration of flexibility).

BRAKES

Brake retractor/brake thruster

Check

- that the cable to the brake is flexible and whether there is any movement in the brake frame.

Brake solenoids Check

- that these are clean. Is there dust from the brake inserts?

- wear on brake inserts.

- the function of any integral auxiliary contacts.

- switching and autotransformer voltages where autotransformer starting is used.

Electrical disc brakes

Check

- that actuating devices work.
- that switching and autotransformer

BRIDGE INSPECTION

Inspection procedure

MAJOR INSPECTION - - ELECTRICAL EQUIPMENT

voltages are in accordance with specifications.

- that a de-energisation pulse is transmitted on stopping.
- braking times.

LIMIT SWITCHES

Check

- that the limit switches operate, so that the risk of damage to the bridge or switches is eliminated
- that the feed cable is firmly attached.

CONTACT SWITCH

Check

- the performance and construction of the contact. The limit switch arm shall move easily and the springs shall be intact.
- with the angle arm in two distinct positions that the arm cannot set itself into an intermediate position during operation.
- that a limit switch which has been actuated (disconnected) in the road traffic position has to be forcibly reset when the bridge is opened, for instance by means of the angle arm.

Rotary switch

Check

- connection to the limit switch.
- that gear wheels and contact sets are undamaged.

Protection against contact

Check

- attachment.
- that the sensor distance is satisfactory.

CONTROL CABINET

Space for cabinet

Check

- that emergency opening device works, that emergency lighting

works.

- that pressure relief is available.
- that firestopping at the cable entry is undamaged.
- that there is a warning sign on the door, that the space is locked, that there is a layout diagram.

Control cabinet

Check

- that the door of the cabinet displays a plainly worded electric warning sign.
- that there is protection against contact for electrical apparatus. At least IP20. This is important near apparatus requiring attendance.
- that the busbar runs are protected against contact both in the cabinet and against the cable duct.
- that terminals are undamaged and marked.



- if terminals need to be retightened.
- that the PE lead is connected in accordance with specifications.
- that cable connectors between moving parts, for instance to doors, are intact and undamaged by wear or overheating.
- that cables are clamped before connection to the terminal block. Check the bending radii also.

BRIDGE INSPECTION

Inspection procedure

MAJOR INSPECTION - - ELECTRICAL EQUIPMENT

- that there are no temporary connections.
- that there are no marks due to overheating where apparatus drawing power is connected.
- that electrical apparatus is rigidly fixed in the control cabinet.
- the setting of protective devices, over-current and overload relays.
- that the main isolating switch and the isolating switches for circuits have signs with clear wording. Automatic circuit breakers alone are not approved for disconnection in the event of work on the apparatus.
- that there is a list of circuits for fuses and circuit breakers. Names of circuits and fuse ratings.
- that fuse carriers are closed and that there is protective glass.
- that there is no discoloration due to overheating.

ELECTRONICS

Check

- that there is no discoloration on circuit boards. Is there overheating?
- that boards are firmly in place, either screwed down or properly inserted.
- that cabling is firmly connected and that screened cables are earthed at the control cabinet.
- batteries and battery chargers where there is battery backup.

CONTROL DESKS

Check

- that all control apparatus and indicator lights have signs which cannot be mixed up.
- that all indicator lights light up both during operation and alarm testing if such equipment is installed.
- that terminals are undamaged and marked.
- if terminals need to be retightened.



REMOTE CONTROL EQUIPMENT

Cabling

Check

- that no malfunctions occur during performance tests.

Remote control desk



Check

- that the required controls are available for safe operation.
- the interlock between the operating positions, so that operation cannot be carried out from both positions simultaneously.
- that TV and radio equipment can be operated and used, so that absolute safety is achieved when the bridge is opened.

TV EQUIPMENT

Cameras

Check

- that there is no malfunction due to vibrations caused by traffic.
- that cabling and connections are undamaged.
- that there is no risk of cables for movable cameras getting entangled.
- that picture quality is satisfactory.

CABLING

Check

- that the cable is permanently installed. There must be no temporary cabling.
- that there is no mechanical damage.
- exposed cables and places where damage is possible, and make insulation tests.
- that the wrong bending radii are not used.
- that no cables press on to sharp edges (including concrete). Special attention should be paid to the risk of cold flow at points of change from horizontal to vertical cable runs.
- that cables are not swollen due to water or oil damage. Cabling must not be laid unprotected underneath gear boxes or hydraulic pipes which may leak oil. If there is damage, make an insulation test.
- that cabling is protected by ducts where it passes platforms or other walkways.
- that cables are protected near machinery or other places where pedestrian traffic occurs.
- that the covers of cable ducts are not loose.
- that underground cables have not become unprotected owing to erosion.
- that there is a warning sign at places where both green/yellow and red earth leads are laid.

Undersea cables

Check

- that there is no insulation fault. This is to be ascertained by an insulation test.

Suspended cables

- that the type of cable is suitable. Junction boxes and terminal units must be accessible.
- that the cable is suspended so that it is not damaged.
- that there is no risk of the cable getting entangled.
- that cabling does not obstruct passage of boats for which the bridge need not be opened.

TERMINAL UNITS / JUNCTION BOXES

Check

- external and internal cleanliness.
- that terminals are undamaged and marked.
- whether terminals need to be re-tightened.
- that there are no provisional arrangements or loose ends.

ELECTRICITY SUPPLY

Check

- that the meter cupboard is undamaged.
- Check that the name of the supplier is stated and that the seals on the meter are undamaged.

STANDBY PLANT



BRIDGE INSPECTION

Inspection procedure

MAJOR INSPECTION - - ELECTRICAL EQUIPMENT

Check

- manual start from the motor and remote start, if any, from the control desk.
- interlock in relation to the incoming mains supply.
- automatic fans and dampers and that there is a safety switch for these.
- the attachment for sensors and heat screens for cabling on hot parts of the motor.
- that the sensors work - on the control desk also.

LIGHTNING PROTECTION

Check

- that cables which are freely suspended in the air are fitted with overvoltage protection.

INSTALLATION IN ROOMS

Substations

Check

- that there are no marks due to overheating.
- that there is protective glass in fuse carriers and unobstructed space in front of the switchboard.

CONNECTED OBJECTS

Check

- that connected objects have approved connectors and connecting cables. New installations shall have earth leakage circuit breakers on 220V sockets.
- protective earth and earth leakage circuit breakers with a socket outlet tester.

TELEPHONE INSTALLATIONS

Check

- that the cable is firmly fixed. If an aerial cable is used, it shall be an approved type. There must be no temporary arrangements.

LOUDSPEAKER INSTALLATION

Check

performance.

TRIAL RUNS

Trial runs should be made when traffic is of low intensity.

Trial runs shall be made using all conceivable operational alternatives:

- * Operation from the control desk
 - With the standby plant
 - Different motor alternatives Redundant drives Different speeds Emergency machinery Remote control desk.

CHECK THE FOLLOWING FUNCTIONS

- **Manual operation interlocks**
- **Interlock between** different items of machinery and signals.
- **Timing circuits**
Delay between red light and barrier lowering > 10 s. Delay in centering swing bridges etc.
- **Override facilities,** barrier interlocks etc.
- **Battery backup** for barrier lights.
- **Emergency stop and normal stop in intermediate position.**
Avoid a stop where there is a risk of damage.
- **Start** in intermediate position
- **Interlocks** between places of operation.
- **Connection of sea signals.** Check and note Operating times
- **All indications** during operation. Current indications for signals must not fail.
- **Instruments.** Note currents at start and during operation of machinery.

GENERAL INSPECTION - PLANNING

A general inspection entails a lot of work which requires good planning if it is to be carried out without any difficulties.

During planning, the following should be taken into consideration and the appropriate action taken.

DOCUMENTATION

The reports on previous inspections, as well as the performance requirements for the maintenance contract and the contractor's verifications, shall be available for the inspection. The appropriate drawings should be taken along if necessary.

TIME

Choose a suitable time of year in view of e.g. water levels and a suitable time of day in view of e.g. traffic. If traffic will be affected, a traffic regulation plan shall be drawn up and approved by the road authority.

ACCESS

Equipment

Investigate what equipment and what aids are required for each bridge, for instance the need for a boat, inspection platform, ladders, lighting, etc.

Doors, shutters or gates are in most cases locked.

Make sure you have a key.

Inspection platform

If damage is found which requires inspection from a distance within arm's reach, an additional inspection is to be made.

It is best to make such additional inspection at a time when several bridges can be inspected.

EXTERNAL CONTACTS

Railway bridges

When bridges over railways, especially those with overhead lines, are to be inspected the track authority must be contacted if there is a risk that inspection will encroach on the risk area for the railway.

This may occur when an inspection plat-

form or similar is used.

The extent of the risk area can be ascertained from the safety regulations of the Swedish Rail Administration.

Bridge watchman

When a movable bridge is inspected, a bridge watchman must be available.

BRIDGE INSPECTION

Inspection procedure

GENERAL INSPECTION - EQUIPMENT

Apart from the equipment listed below, personal equipment and traffic control equipment will also be needed - see the section "Working environment" on p. 134.

EQUIPMENT

- Chipping hammer, hammer and chisel, knife, plumb bob, marking chalk, rope.
- Torch, telescope and compass.
- Tape measure.
- Folding rule, telescopic bar (5 m), cali-per gauge.
- Thermometer.
- Crack width gauge. Ladders and thigh boots.

ACCESS EQUIPMENT

If there is damage which shall be inspected from a distance within arm's reach, in most cases some kind of access equipment is needed.

See the section "Major inspection - Equipment" on p. 82.

GENERAL INSPECTION -

Before the inspection starts, the reports from previous inspections must be read. A study must also be made of the bridge and its mode of action. Also examine the performance requirements specified with regard to the maintenance contract.

The inspection procedure can be divided into three stages.

1. Follow up of the assessments, made at the time of the most recent major inspection, of damage which has not been put right.
2. Discovery and assessment of damage which, if not detected before the next major inspection, would result in unsatisfactory loadbearing capacity or traffic safety or in substantially increased administration costs.
3. Checks to ensure that the performance requirements specified in the maintenance contract have been complied with.

DAMAGE WHICH HAS NOT BEEN PUT RIGHT

In the case of damage which had been detected before and has not been put right, the first thing to do is to assess its development. If the assessment is different from that made at the time of the most recent inspection and the result may be unsatisfactory loadbearing capacity or traffic safety or substantially increased administration costs, the damage shall be assessed from a distance within arm's reach and subject to the requirements applicable to a major inspection.

NEW DAMAGE

At the time of inspection, damage which, if not detected before the next major inspection, would result in unsatisfactory loadbearing capacity or traffic safety or in substantially increased administration costs, shall be detected and assessed. If such damage is detected, it shall be assessed from a distance within arm's reach. In the case of other damage no assessment is to be made before the next major inspection.

A number of damage situations which may affect loadbearing capacity, traffic safety and administration costs are described below.

FOUNDATIONS

Check that there are no large areas with exposed corroded reinforcement.

Make sure that concrete surfaces have no cracks due to loading or crushing damage caused by impact with vehicles/shipping.

Bridges in watercourses with strong currents are to be checked for damage to revetments, fill etc.

SLOPES AND EMBANKMENT ENDS

Check that no major settlement has occurred between bridge and road embankment. This may give rise to undesirable impact loads on the bridge structure.

SUPPORTS/WING-RETAINING WALLS



Fig. Pier with corroded reinforcement.

Corrosion

Check that there are no large areas with exposed corroded reinforcement. Elements which are specially exposed are bearing seats underneath leaky expansion joints, piers and abutment breast walls exposed to chloride and water spray from road traffic, and structures in a marine environment, chiefly in the splash zone.

BRIDGE INSPECTION

Inspection procedure

GENERAL INSPECTION -

Cracking

Examine concrete, stone and steel surfaces for cracks due to loading.

Crushing

See if the structure has crushing damage due to impact by vehicles/shipping.

Loosening

On elements of stone, check that stones are not loose, displaced or missing. Be particularly observant at bridges over flowing water.



Crushing

Check whether there is any damage on the concrete structure due to impact by vehicles; this is most common on ties and on the soffit of beams/slabs above the carriageway.

Check whether there is any displacement between units in precast bridges.

BEARINGS

Check that steel and elastomeric bearings are free from cracks, and that the fasteners for the bearing are fully effective.

Check that the bearings are aligned correctly in view of prevailing temperature conditions. If the alignment is incorrect, check for movement of supports.



MAIN AND OTHER LOADBEARING ELEMENTS

A. LOADBEARING ELEMENTS OF CONCRETE

Corrosion

Check that there are no large areas with exposed corroded reinforcement

Cracking

Investigate loadbearing structural elements of concrete for major cracks due to loading. Note that prestressed structures shall not normally have any cracking.

B. LOADBEARING STRUCTURE OF STEEL

Cracks

Check steel structures for cracking. Exposed positions are bolted and riveted connections and, for instance, the suspender attachments on a bow-string girder bridge. Check also that suspenders are correctly tensioned by comparing the ring emitted in response to a light tap. Check also whether suspender attachments of suspension bridges have been displaced along the main cable.

Deformation

Check for abnormal deflection of the structure. This can be studied most easily by following the alignment of the parapet.

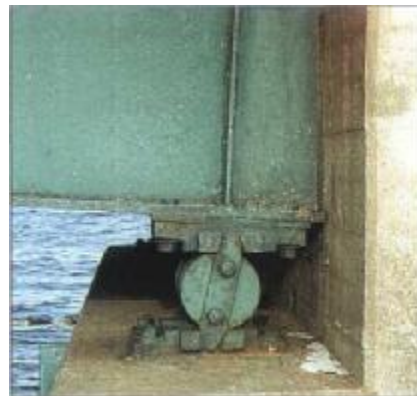

Check flanges, web plates, struts and ties, suspenders and transverse members for damage of all kinds, buckling and deflection.

Check that steel pipe culverts are not deformed.

BRIDGE INSPECTION

Inspection procedure

GENERAL INSPECTION -

C. LOADBEARING ELEMENTS OF STONE

On the intrados and side walls of earth filled arch bridges, check if any stones are loose, missing or displaced.

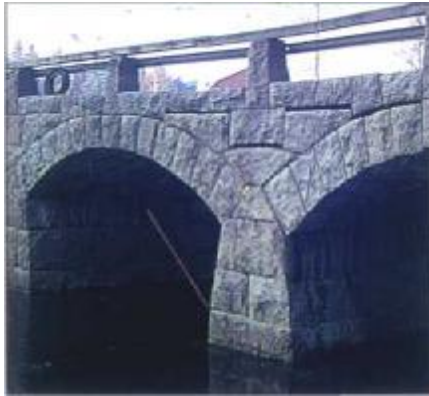

Settlement in the carriageway above the arch indicates settlement in the arch.

BRIDGE DECK SLAB AND EDGE BEAMS

Check that there are no large areas with exposed corroded reinforcement.

Examine the slab for cracks due to loading or crushing damage due to impact by vehicles.

On a bridge deck of timber, check that deck planking and crossbeams are firmly attached and that nails have not started moving upwards.

If there are gaps between timber planks/aluminium planks, this is probably due to loose fasteners.

SURFACING

Make sure that any rutting does not adversely affect road safety.

Make sure that there is no blistering on mastic asphalt surfacings, since this can give rise to road safety problems.

There shall be no holes in the surfacing.

If there is crazing in the surfacing, this often indicates that the underlying concrete protection course is damaged. In the long run, this may give rise to increased administration costs.

PARAPET

Check the parapets for deformation.

EXPANSION JOINT

Check by tapping that the fasteners are effective. Check if there is damage/fracture in cover plates or bearers.

Check that the joint opening is correct in view of the prevailing temperature.

MAINTENANCE CONTRACTS

Check at the time of the inspection that the performance requirements specified in the maintenance contract have been complied with. Any deviations shall be measured up and documented. Use the methods of measurement set out in "Measurement and condition assessment of bridges", Publication No 1996-038 (E).

WELDS

PLANNING

See the section "Major inspection - Planning" on p. 80.

EQUIPMENT

- radiography equipment
- ultrasonic equipment
- see the section "Major inspection - Equipment" on p. 82.

PROCEDURE

Welds are inspected to detect internal and external defects.

Radiographic and ultrasonic tests are methods in common use to check for, and detect, internal defects in welds. Examples of defects are porosity, non-metallic inclusions, root defects, incomplete penetration and internal cracks. For certain types of cracking and incomplete penetration, ultrasonic tests are preferred.

Radiographic and ultrasonic tests complement one another.

These methods are described below in detail.

RADIOGRAPHY

Radiography can be applied only to butt welds. It is to be performed in accordance with Swedish Standard SS 11 41 01, Class B, with the image quality in accordance with SS 11 41 30, Class B. Radiograms shall be interpreted in accordance with SS 11 41 01 and SS 06 61 01.



Fig. Control panel and x-ray tube.



Fig. Mounting of x-ray film.



Fig. Test in progress.

Radiography

Radiography is performed using equipment comprising an X-ray tube, cables and control panel.

The X-ray tube generates a beam of rays of different wavelengths. The electrons in the beam are accelerated by very high voltage and are retarded by a suitably placed metal plate.

Radiography

is based on utilising the ability of the X-rays to blacken an X-ray film. Differences in intensity in the exiting radiation due to defects in a weld, for instance a crack, can be made visible by the differences in density on the film.

Documentation

An X-ray film consists of a transparent and flexible substrate coated on both sides with a photosensitive material. A radiogram is excellent documentation of e.g. welds, and can be archived for an unlimited length of time.

ULTRASONICS

Ultrasonic tests can be used on all kinds of welds. They are to be performed in accordance with SS 11 42 01 and SS 06 61 01.

Ultrasonic test

Ultrasonic tests are performed using ultrasonic test equipment. This comprises a transducer with both transmitting and receiving function, and an oscilloscope on which the results are presented. Ultrasonics uses sound waves at a frequency above the threshold of audibility (ca 16,000 Hz). These can be propagated in solid bodies such as steel, but not in air.

Ultrasonic tests can be made in many different ways. The most common method is to apply the ultrasonic beam to the steel material with a transducer. The sound is transmitted into the material via a couplant which is a thin film of oil or water.



Fig. Test procedure.

Documentation

Documentation can be effected by means of a printer or monitor. The oscilloscope can also be photographed.

WATERPROOFING

PLANNING

- If traffic is affected, a traffic regulation plan is to be drawn up and approved by the road authority.

EQUIPMENT

- Survey vehicle with pulse radar equipment.

PROCEDURE

Pulse radar

By using pulse radar, the effectiveness of the inspection of waterproofing on bridge deck slabs can be enhanced. There is a high degree of probability

that damage will be detected at an early stage.

When pulse radar equipment is used on bridge decks with waterproofing and surfacing, computerised signal processing must be applied in order that the results may be made comprehensible.

Examples of the deviating properties which can be measured are local differences in

- moisture content
- salt content
- course thickness
- voids ratio.

Readings

can be presented, for instance, in the form of colour coded maps of the carriageway. With the help of such maps deviations can be located with an accuracy of ca 0.2 m.

The best and most practical way of producing this map is to use equipment comprising several parallel mounted radar antennae.

The equipment can be mounted on a survey vehicle, which allows a road width of ca 2.5 m to be mapped at normal vehicle speed.



Fig. Survey vehicle with five radar antennae.

The temperature of the deck slab and the surroundings must be above 0° C, and the road surface should not have been salted recently.

When leakage has been detected or is suspected, samples shall be taken. Sampling is described in greater detail in the chapter "Measurement, Sampling - Concrete surfaces below the waterproofing", p. 150.

BRIDGE INSPECTION

Inspection procedure

SPECIAL INSPECTION - MECHANICAL AND ELECTRICAL EQUIPMENT

MECHANICAL AND ELECTRICAL EQUIPMENT

1. PLANNING

See the section
"Major inspection - Planning", p. 80.

2. EQUIPMENT

See the section
"Major inspection - Equipment", p. 82.

3. PROCEDURE

See the section
"Major inspection - Mechanical and
electrical equipment", pp. 105 & 111.

BRIDGE INSPECTION

Inspection procedure

DOCUMENTATION

In conjunction with the inspection, a number of data must be documented. The extent of these data and the requirement for documentation depend on the type of inspection performed, and are set out below.

REGULAR INSPECTION

This inspection is performed continuously by the maintenance contractor as he inspects the road network. During this inspection, acute damage which may affect the safety of traffic and the integrity of the structure in the short term shall be noted. The required documentation and verification are set out in the contract documents drawn up between the client and the contractor.

SUPERFICIAL INSPECTION

This inspection has the aim of verifying that the requirements specified in the maintenance contracts are complied with. The required documentation and verification are set out in the contract documents drawn up between the client and the contractor.

GENERAL INSPECTION, MAJOR INSPECTION AND SPECIAL INSPECTION

During these inspections, the damage detected shall be subjected to condition and action assessments and these shall be noted. The data are to be documented in the ADP based information system Brodata which is used by the whole of the Road Administration organisation and is part of the Administration's bridge administration system SAFE. The inspection data must therefore be ADP compatible, and for most of the information numerical codes are available according to a separate code schedule, Publication No 1996-037 (E). The inspection data can be entered in two alternative ways.



Alternative 1 (above) Data are noted in the inspection record sheet and later recorded in a processing module which is part of Brodata.



Alternative 2 (above) Data are entered directly at the time of inspection in a portable PC. The data are later transferred to Brodata.

The actual ADP processing is described in the user manuals for SAFE/ BRODATA and is not dealt with here.

In view of the above, the following inspection and damage data shall be noted or recorded for each type of inspection with the exception of general inspection.

For general inspection, damage data are not required where previously or newly detected damage is not judged to entail unsatisfactory loadbearing capacity and/or road safety, or result in substantially increased administration costs during the period up to the next major inspection. In such a case, only the inspection data such as structure number, inspection date, inspection type, inspector, next inspection year and next inspection type, are to be noted or recorded for a general inspection.

When there are several structures

In the normal case a bridge comprises only one structure, but if there are several, the inspection is to be recorded for each structure.

When the major inspection is not completed

A major inspection may have to be made on two separate occasions, for instance the underwater inspection may be made later using divers. In order that the inspection data from the first occasion should not be filed away and forgotten, these data can be recorded in Brodata as an incomplete major inspection. The codes for noting on the sheet or recording in the PC are set out in the code schedule. At the time of inspection, the inspection which remains to be done is to be noted or recorded under "Free text" (see below). When the inspection of the bridge has been completed, Brodata is to be updated with the additional data. A major inspection cannot be made on two separate occasions unless it is certain that inspection of the bridge can be completed within the planned inspection year.

INSPECTION DATA

Structure number of the bridge, county letter and consecutive number in the county.

Inspection date, year, month and day. Inspection type according to the code schedule.

Inspector, initials.

Next inspection, year and if necessary the month. It is the inspector who decides on the next inspection year on the basis of the condition of the bridge, bearing in mind the maximum time interval according to the inspection requirements.

Next inspection type according to the code schedule. It is the inspector who decides on the next inspection type on the basis of the condition of the bridge, bearing in mind the inspection requirements.

Whether or not the technical service life is expected to be achieved is to be stated by yes or no. Applies only for major inspections, and the conditions are set out in "Measurement and condition assessment of bridges", Publication No 1996-038 (E).

DAMAGE DATA

For each damage, the following shall be noted or recorded:

Damage number which is at all times associated with the same damage even if the damage is put right. For the damage to be the same, it is stipulated that the damage should be situated on the same structural member or element and that the same material should be damaged, with the same type and cause of damage. If damage is located at different places on the bridge, its position is to be described as below.

Each damage number is allocated a version number, for instance damage No 1 and version No 1 is given damage number 1.1. If at the next inspection this damage is found to have changed, the damage number is still 1 but the version is No 2. The damage is noted or recorded as 1.2.

The structural member which is damaged. Code as per the separate code schedule, Publication No 1996-037 (E). If in doubt as to which element is damaged, refer to the chapter "Definitions", section "Structural members and elements", p. 35.

The damage code comprises the material which is damaged, the type and cause of damage. Help in deciding on damage type and possible cause will be given by the chapter "Definitions", section "Types of damage", p. 62. Codes are given in the separate schedule of codes, Publication No 1996-037 (E). In selecting the cause code, there are six main groups to choose from, and these are to be selected if it is not possible to use any of the subcodes. The following examples of damage show the choice of damaged material, type and cause of damage. The soffit of a reinforced concrete beam has corroded reinforcement which is visible due to spalling of the concrete.

BRIDGE INSPECTION

Inspection procedure

DOCUMENTATION

On measuring the depth of carbonation, it is found that the front has reached the reinforcement.

- the damaged material is the reinforcement
- the type of damage is corrosion
- the cause is carbonation.
- An edge beam has exposed reinforcement on the top and on the outside due to loss of concrete. There is no carbonation.
- the damaged material is reinforced concrete
- the type of damage is weathering
- the cause is frost action.
- A concrete main beam has exposed reinforcement and spalled concrete on its soffit. Carbonation has only penetrated into the concrete by 2-5 mm.
- the damaged material is reinforced concrete
- the type of damage is spalling
- the cause is traffic load.

Structural member type denotes the type, make etc of the structural member or element. In this way development of damage may for instance be observed for a certain type of expansion joint. Optional information

Location data specifies the position of damage on the bridge. This information is optional and is used when it is judged that it may be useful in finding the damage at the next inspection, or as the basis for more detailed technical investigations.

Abutments and piers are numbered according to the general arrangement drawing or in the principal direction SW -> NE.

Location data can be written down or given according to the following system.

Longitudinal orientation

The bridge is longitudinally oriented in

the principal direction SW —► NE. The abutments and piers are numbered in the same direction, i.e. 1, 2, 3... The numbering should agree with the general arrangement drawing.

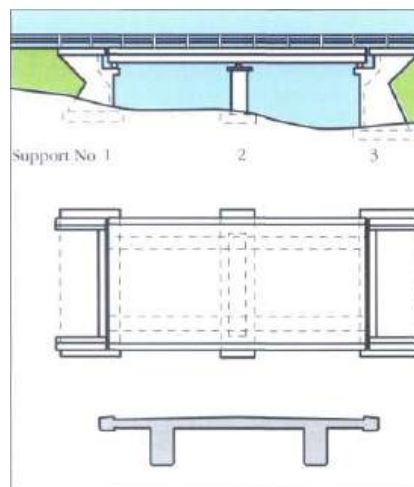

Superstructure

A point in the horizontal plane along the bridge is denoted by a decimal, (m+1), where "m" is the ordinal number of the immediately preceding support and "1" is the relative position in span m - (m+1) measured from the support m.

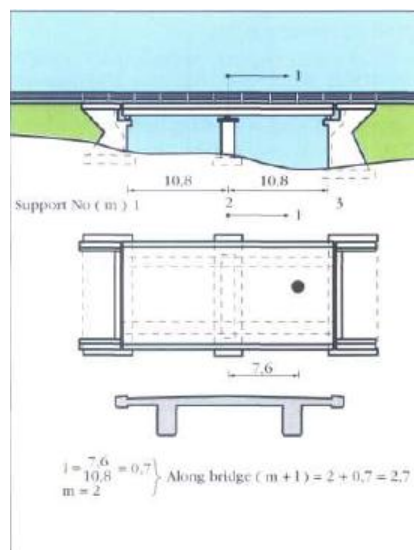

If the bridge slab projects beyond the abutments, 1 and p, the ends of these portions of the bridge slab are given the decimal figures 0.0 and (p+1).0, respectively.

BRIDGE INSPECTION

Inspection procedure

DOCUMENTATION

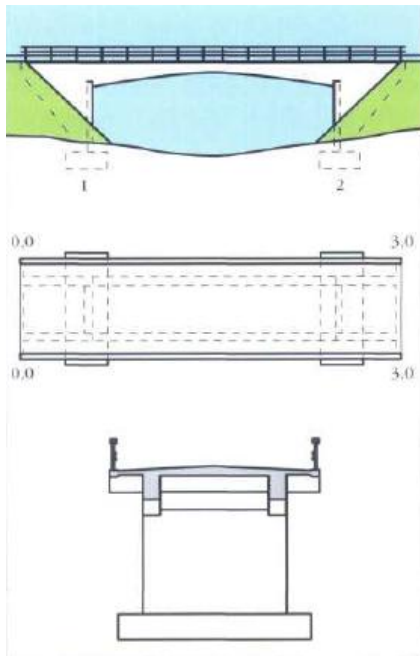

In the transverse direction also, a point is denoted by a decimal number, $(n+b)$, where "n" on girder bridges denotes the ordinal number of the main girder or edge beam, and "b" the relative position between the girders. The left edge beam, seen along the principal direction of the bridge, is given No 0 and the one on the right the number $(q+1)$, where q is the number of main girders. On slab bridges, $q = 0$.

Beams (including edge beams) are denoted by whole numbers.

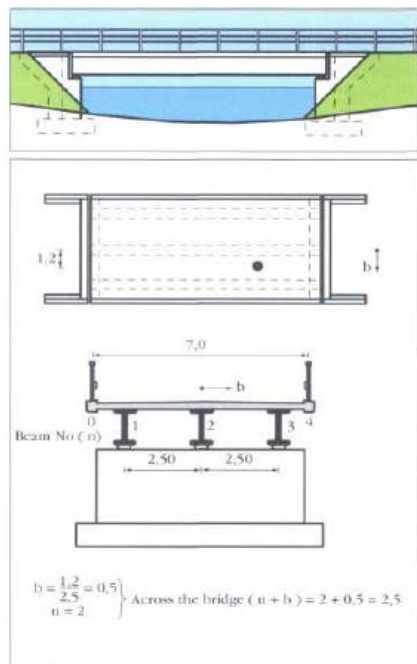

Substructure

In the longitudinal direction, supports are denoted by whole numbers and in the transverse direction according to the same principle as for the superstructure. This means that the transverse notation is either a decimal number, 0.0 - 1.0 as for an abutment, solid wall pier etc, or a whole number 1, 2,3 ... in the case of a column pier.

Vertical position is denoted in essentially the same way as above, in the direction bottom to top. For a pier, for instance, the junction with the base slab is given the figure 0.0 and that with the superstructure the figure 1.0. Vertical position is given after the transverse position and is preceded by "/", which must be specially recorded in this case; see below. (It is presupposed that there is space for the vertical position also).

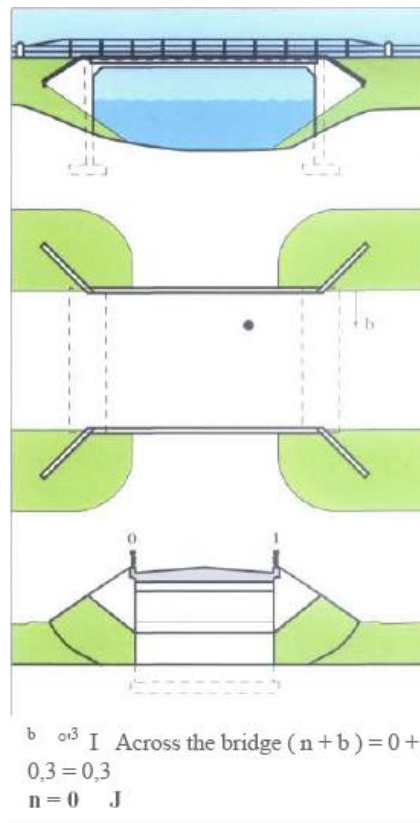

Other rules

In each principal direction, a point is denoted by one figure, e.g. 4 or 2.2, and a distance by two figures, e.g. 4-8 or 2.2-3.5.

Several positions in the same principal direction are separated by ";".

Longitudinal direction is given before transverse direction.

After the transverse indication, further positional information can be given, such as vertical position, T (top), B (bottom), I/S (inside), O/S (outside), TS (top face), BS (bottom face), etc. All designations, at least the numerical ones, must be separated by "V".

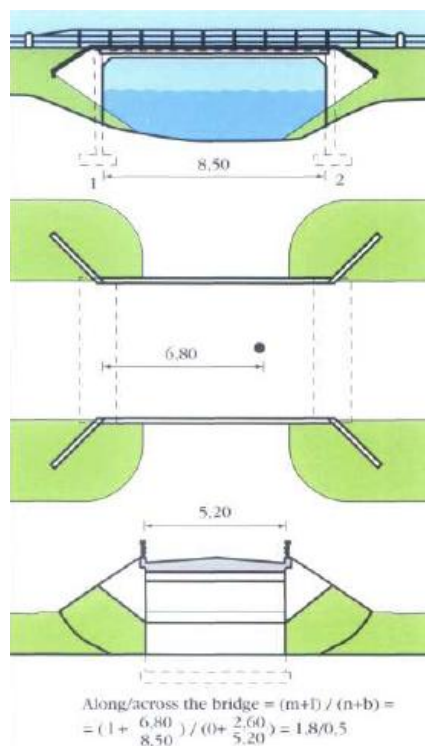

Report number if a separate report has been produced about the damage. This will make it easy to remember that a report is associated with a specific damage.

Photograph number if the damage has been photographed. This makes it possible for development of a damage to be followed up.

Physical condition is stated with method of measurement and measured value. Measurement of physical condition is carried out according to "Measurement and condition assessment of bridges", Publication No 1996-038 (E).

For most types of damage, with the exception of small damage such as flaking and erosion, a measuring method and measured value can be quoted.

There may also be special damage for which there are no measuring methods.

Several measuring methods may be

appropriate for a certain damage. The following may for instance have to be studied for a damaged column:

- loss of bond for main reinforcement
- loss of bond for stirrups
- loss of area from a concrete cross section
- corrosion of main reinforcement
- corrosion of stirrups

Only one measuring method with the associated measured value, which describes the primary damage mechanism, need normally be noted or recorded. If there is reason to follow several damage mechanisms, further information relating to measuring methods and measured values can be given under "Free text"; see below. Performance of measurements requires knowledge of a number of technical terms which are described in the chapter "Definitions", section "Terms used in measurement", p. 74.

Functional condition is stated in terms of condition classes in accordance with "Measurement and condition assessment of bridges", Publication No 1996-038 (E). In assigning structural members to condition classes, consideration shall be given to the performance requirements for the member.

Activity relates to the notional action for the damage found at the time of inspection and is given with a code according to a separate code schedule, Publication No 1996-037 (E). (The actual action is determined when plans are drawn up for the whole bridge).

Quantity states the extent of damage at the time of inspection, and only the quantity which is damaged. Possible units are set out in the separate code schedule.

Rates for a number of activities are stored in Brodata. If no rate is given, this can be input by the inspector.

Cost is calculated automatically provided that quantity and rate are given. If it is difficult to quote a quantity, the inspector may state an estimated damage cost, for instance SEK 400,000 to put right settlement at a support.

Free text may relate to additions, explanations, etc.

Defective condition

Apart from actual damage, there may be

BRIDGE INSPECTION

Inspection procedure

DOCUMENTATION

other defects. These are described in the chapter "Definitions", section "Types of damage", p. 62.

For each defect, the same data as above are to be noted or recorded, with the exception of functional condition.

WORKING ENVIRONMENT

According to the Working Environment Act (AML), it is the employer who bears the principal responsibility for the state of the working environment. He shall take all the action necessary to prevent an employee being subjected to ill health or an accident.

This implies, inter alia, that the employer shall in each individual case take into consideration the physical and mental qualifications of the employee for the work at hand.

The employee shall, in his turn, contribute to making the working environment as good as possible. This is done by complying with the regulations, using the safety devices and taking the necessary⁷ care to prevent ill health and accidents.

Brief information regarding certain safety measures which must be taken during an inspection is given below. This list makes no claims to being complete. In addition to what is stated below, further regulations have been published by the Swedish Board of Occupational Safety and Health, regulations which in their entirety or in their relevant parts are applicable to this work. A full compendium of the regulations should be available and studied before work begins.

EMPLOYEE WORKING ALONE

It is a fundamental requirement when an employee is working alone that contact facilities should be available with the person performing the work, so that he/she can get help in the event of an accident or illness.

The scope of this preparedness is obviously dependent on the kind of work, the type of machinery/tools used, the situation of the workplace, etc.

Issues relating to working on one's own and the need for action must be judged in view of local conditions. The inspector should have a portable telephone with him/her.

PERSONAL SAFETY EQUIPMENT

If adequate protection against ill health or accident cannot be achieved in some other way, personal safety equipment shall be used.

The following safety equipment is relevant to work during an inspection:

First aid box

Safety clothing

Approved safety clothing shall at all times be worn for work on and near roads.

Safety helmet

For an inspection where there is a risk of head injury, e.g. inside a bridge, on an inspection platform or cradle, a safety helmet shall be worn.

Ear protection

For an inspection in a noisy environment, e.g. near machinery or a motor driven compressor, pneumatic tools etc, ear protection shall be worn.

Eye protection

For an inspection where there is a risk of eye injury, suitable eye protection shall be worn.

Breathing apparatus

For an inspection which entails harmful or excessive dust, smoke or similar, an appropriate breathing apparatus shall be used.

Safety belt with line

For an inspection where there is a risk of fall, a safety belt with line shall be used. For an inspection which requires a large measure of mobility, the line shall be attached to a fall arrest device if the line cannot be kept taut during the inspection. The equipment used shall be handed once a year to an authorised person for inspection unless the supplier/maker specifies a greater frequency of inspection.

SAFETY DEVICES

Inspection on or near a road

Before an inspection on a road commences, a traffic regulation plan shall be drawn up and approved by the road authority.

WORKING ENVIRONMENT**Inspection near a railway**

No person shall be present in the proximity of a live overhead line without the attendance of supervisory personnel from the railway company. If necessary, the supply shall be turned off.

Inspection at great height

Inspection at great height shall be avoided in strong wind, heavy snow fall or other weather conditions which involve a greatly increased risk of fall.

Ladders shall be of approved construction and marked with the maker's name, year of manufacture and type designation.

Inspection from an inspection platform

Inspection from a cradle or platform shall not be performed by one person only. The driver of the vehicle shall be in constant telephone/radio contact with the person in the cradle or platform, preferably complemented by TV surveillance as a precaution in the event of telephone breakdown. Operation of the cradle and platform shall be possible from both these and the vehicle. There shall be an attachment for a safety belt with line. In the cradle and platform there shall be an emergency stop button which stops these and the vehicle. The equipment shall be annually inspected by an authorised test institute. It shall in addition be under constant recorded supervision.

Inspection near water

During an inspection near or above water where there is a risk of drowning, a life jacket shall be worn.

When inspection is made from a boat, a life buoy and boat hook shall also be available.

Inspection in water

Diving equipment shall have been inspected and approved. A warning flag "Diving in progress" shall be flown. The Swedish Board of Occupational Safety and Health has published Diving Instructions which shall be complied with. The most recent one is No AFS 1993:57.

Inspection on a movable bridge

A safety sign with the text "Inspection in progress. Bridge may only be operated when permitted by the inspector" shall be attached to the control desk.

BRIDGE

Measurement, Sampling - Description

C O N T E N T S

CONCRETE (138 - 148)

Field methods (138 145)
Laboratory tests (145-147)
Other test methods (147-148)

BOTTOM PROFILES (149)

**Manual sounding line (149) Electronic depth
meter (149)**
**Echo sounder (149) High frequency sonar
(149)**

CONCRETE SURFACES BELOW WATERPROOFING (150 - 152)

**Visual inspection (150) Repair after inspection
(151 152)**

STEEL (153 -157)

Nondestructive testing (153 155)
Destructive testing (155-156)
Check on surface treatment of steel (156)
Bolted and riveted connections (157)

MECHANICAL EQUIPMENT (158)

Sampling on concrete structures is mainly carried out to determine compressive and splitting strength, frost resistance, chloride ion concentration, degree of carbonation and thickness of concrete cover.

In the following, these tests and some other test procedures which are not used very often are described in detail.

FIELD METHODS

COMPRESSIVE AND SPOTTING STRENGTH

In determining the strength of a bridge, an overall view is essential. Both the "best" and "worst" positions are therefore of interest for the test. If only the "best" positions are chosen, the load-bearing capacity of the bridge can be over-estimated.

The taking of cores to determine the strength of concrete is described in detail below.

Cores

Cores are drilled out of the completed structure. The term test specimen refers to that part of the core which is used in laboratory tests.

Core dimensions

When a core is drilled out of a concrete structure, a diameter of 100 mm is to be aimed for.

The length of cores shall be such that the intended tests can be carried out.

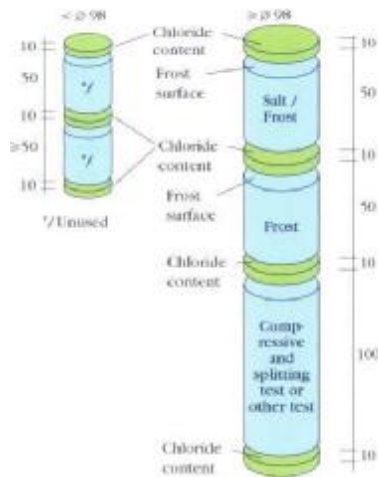

For compressive and splitting strength, a test specimen length of 100 mm is required for each test. With a test specimen of this dimension (100 * 100 mm), the results can be directly compared with those for a cube of 150 mm sides. The term test specimen in this context refers to a part of the core which is not affected by e.g. reinforcement, decomposed concrete, etc.

Placing

As a rule, the places where samples are taken on the structure are selected at random. In the case of vertical structures, it is known that the strength at the top is generally lower than that at the bottom. It is therefore reasonable for both the upper and lower parts of these structures to be represented. The appropriate drawings shall be studied so that collision with electric cables, prestressing cables, main reinforcement, embedded details, void formers and similar is avoided.

The structural element and site of sampling should be selected in consultation with a bridge designer. The safety of the person taking the samples, and also the integrity of the structure, shall not be jeopardised.

If, for instance, the bridge is over an electrified railway, care must be taken in draining the water from the sampling process.

Unintended drilling through the deck slab, or leakage of waste water through the slab, down to a live cable will with the greatest probability entail danger to life.

Number of samples

At least three cores must be taken for determination of both the compressive and splitting strength, i.e. at least twice three cores.

If it is to be possible for strength greater than K 45 to be utilised, at least twice nine cores must be drilled out.

If cores are taken from several structural members, at least twice three specimens should be obtained from each member. In the case of larger structures, more cores should be drilled out and therefore more specimens tested.

Drilling in the field

When cores are taken, the sampling sites and the cores must be documented on a sketch, and the cores also marked in relation to this. The sketch shall accompany the cores to the testing institute.

Swedish Standard SS 13 11 13 specifies how cores shall be drilled and treated for strength determination.

**Drilling of cores**

Before drilling commences, the position of reinforcement should be determined to prevent its being cut. This can be done with a cover meter.

On bridges over a railway with live overhead lines, the deck slab shall not be drilled through within a distance of 4.5 m from the line.

If samples must be taken nearer the line, drilling can be carried out to half the slab thickness.

It is not the intention that cores of the right size shall be drilled out "at any price". A core of a certain length may perhaps be replaced by two cores from the same place. For instance, a core 200 mm long can be replaced by two cores taken near one another, each of 100 mm length.

What is most important is that a compressive and splitting strength sample should be taken from the same place. Drilling of several cores may be necessary in the case of small cross sections, a lot of reinforcement, damaged concrete etc. Note that this must be shown on the sketch of the structure. A photograph can be of great help in judging the condition of the cores. A coloured photocopy on paper is preferable.

Other observations

It is essential for the overall view that all observations relating to sampling should be noted down.

Observations during sampling, e.g. local weaknesses, should be documented and possibly commented on in a suitable manner. If there is any uncertainty during sampling, a bridge designer should be consulted. The cost of additional sampling is obviously lower if the equipment need not be set up another time.

Other methods for determination of compressive strength

Apart from drilling out cores, in situ tests for determination of strength can be carried out by the following methods:

- ultrasonic measurement
- rebound hammer test
- combined ultrasonic and rebound hammer test
- indentation test with a ball hammer
- penetration test, for instance the Windsor probe test
- core bending test, e.g. the TNS method or the BO test

These methods are described in the materials section of the Concrete Manual and also in most cases in Swedish Standards.

Determination of strength

in the completed structure using e.g. the above methods requires a special permit.

If compressive strength is determined in a way other than by using drilled cores, less reliable results are obtained. One of the reasons is that the compressive strength is measured indirectly via other parameters.

However, in structural members which are sensitive to having large bits of concrete drilled out, the above methods of measurement can provide a useful supplement.

MEASUREMENT OF DEPTH OF CARBONATION

Carbon dioxide which penetrates into concrete from the air reacts with the calcium hydroxide in concrete. This process, called carbonation, results in a lowering of the pH value of concrete from 12-13 to 7-8 and thus in a considerable reduction in the protection provided against the corrosion of reinforcement.

This lowering of the pH value can be shown by a change in the colour of a suitable indicator. The indicator liquid comprises 3-0% by weight of phenolphthalein in ethanol (denatured). This liquid turns red in an alkali environment (pH>9.2) but remains unaltered at lower pH values.



Fig. Measurement of depth of carbonation.

The method should not be used

if the pH value has been affected by factors other than carbonation of concrete. The value may also be lowered by other acid gases such as sulphur dioxide or hydrochloric acid.

The results of measurements may also be disrupted by temporary re-alkalisation.

Moisture migration through the concrete may result in all alkali being transported to the surface. This raises the pH value of concrete and the indicator liquid shows that no carbonation has occurred.

Sampling

Samples are taken by drilling cores of at least 50 mm diameter, or in some other suitable way. Sampling shall be done so that no unnecessary water is added to the sample. Determination of depth of carbonation is described in SS 13 72 42.

Tests may also be made directly in the completed structure by chiselling a hole for testing. The indicator liquid is sprayed in after the hole had been blown clean.

The test shall be made on a surface which had not previously been in direct contact with air. The concrete surface is carbonated relatively rapidly, and an erroneous result can therefore be obtained.

Assessment of the depth of carbonation

Assessment of the depth of carbonation should be based on a mean value from several samples. There should be at least three samples per sampling site.

The test is to be made where maximum carbonation can be expected, for instance the soffit of a bridge deck slab or a surface protected from rain.

The concrete cover to reinforcement should be measured simultaneously with measurement of depth of carbonation.

MEASUREMENT OF CONCRETE COVER

In order to determine the concrete cover and the size of reinforcement, the reinforcement can be exposed by breaking out some of the cover. Charting of the position of reinforcement in this way over larger areas is difficult, but should be done to check indirect methods such as electromagnetic measurement.



Electromagnetic measurement of the concrete cover is based on the interference which the reinforcement causes with the magnetic field generated by the instrument. With some instruments, both the cover and the bar diameter can be estimated.

The depth of penetration varies, but in some instruments it may be as much as 100 mm. The diameter of the reinforcing bar must generally be known. Where there are several layers of reinforcement, interpretation of the readings may be difficult.

Bars situated at a greater depth can be located by radiography which is however an expensive method with serious limitations, and it is consequently seldom used for this purpose. See also "Other test methods", p. 147.

CHLORIDE MEASUREMENT

The presence of water soluble chloride ions greatly increases the risk of frost damage and reinforcement corrosion. Damage has usually progressed far in concrete of low frost resistance in which the concentration of chloride ions exceeds 0.3% of the weight of cement.

Such concrete rapidly loses its strength and cohesion and should therefore be removed and replaced by air entrained concrete of good quality. At concentrations of 0.15-0.30%, the degradation process in concrete may have commenced. Chloride ion concentrations below 0.1% are considered harmless.

Tests have shown that the water soluble chloride ion concentration in concrete to which chlorides have not been added during manufacture and which has not been exposed to de-icing salts may be as much as ca 0.15% owing to impurities in the aggregate, cement and water.

Measurement of chloride content

in a structure is made only if the concrete is suspected of containing chlorides. Testing is usually necessary when e.g. the waterproofing is opened up, when columns are stained by de-icing salts, etc. Columns at the side of the road should be tested on both the near side and outside.

At least three measurements should be made at each test site and at least three test sites per structure should be selected.

The results of the initial measurements decide whether further sampling is necessary. A test site should also be selected at some part of the structure which has not been exposed to chloride spray. This test constitutes a reference for the other tests and may also determine the "original" concentration of chlorides in the concrete concerned.



The RCT (Rapid Chloride Test) equipment

is an example of measuring equipment which is designed for the measurement of chlorides in concrete both in the field and in the laboratory.

The size of the equipment is such that it can be carried in an attache case. Mapping of the presence of chlorides in concrete can be performed without any major interference with the concrete.

Concrete samples are drilled out of the structure and dissolved in an acid solution, after which measurement and evaluation can be carried out directly.

More detailed description of the measurement procedure can be obtained from the supplier of the equipment.

CRACK MEASUREMENT

Crack widths are measured with a graduated pocket lens. This usually has a magnification of about 10x and is graduated in 0.1 mm.



Fig. Measurement of crack in concrete.

TAPPING

In assessing the function of a structure, tapping with a hammer is in many cases a rapid way of locating concealed defects such as lack of adhesion, stratification, cavities, cracks, low strength, etc. It is however necessary for the inspector to be experienced in this procedure and to have a feel for it.

MEASUREMENT OF ELECTRIC POTENTIAL

Whether or not conditions exist for reinforcement corrosion is assessed by measurement of electric potential. Such measurement may be performed in accordance with ASTM C 876, complemented by visual observation. Measurement of electric potential can detect reinforcement corrosion long before it has had time to assume harmful proportions. In order that it may be used as a decision base, the method must at all times be complemented by measurement of the electrical resistance, chloride content, depth of carbonation etc of the concrete.

Corrosion of reinforcement

is governed by several factors such as availability of oxygen, moisture, chlorides, etc. Mapping of potential must therefore usually be related to actual corrosion. For this reason, reinforcement must be exposed and visually examined at some points.

The difference in potential

between the concrete surface exposed to air and the reinforcement in this is measured with a voltmeter. Measurement of potential presupposes that the concrete is damp and the air is humid. For an indicatory measurement, for instance during a major inspection, wetting of the measurement surfaces may be sufficient. In order to ensure that measurement conditions for a condition assessment are satisfactory, the concrete should be prewetted for at least 48 hours.



Fig. Measurement of electric potential.

Measurement under water

Measurement of electric potential is not a suitable method for the detection of corrosion in concrete under water. Considerable corrosion may occur without the generation of corrosion products which cause swelling. The only reliable method which is available today for the detection of reinforcement corrosion under water is to visually examine a cleaned concrete surface. This may need the assistance of a diver.

SAMPLING IN WATER

Sampling and measurement of concrete in water are carried out as for structures above water. Obviously, there are certain limitations and difficulties. The equipment must be adapted for drilling, measurement etc under water. To a greater extent than in the case of structures above water, the inspector is dependent on visual inspection methods.

Concrete cast below water

Cores should be drilled from the top downwards.

This procedure gives a picture over the entire depth of the base slab. Note that drilling must be stopped when about 0.2 m of the slab thickness remains in order to prevent damage to the subsoil. At least one half of the cores must be drilled at an angle (30-60° from the vertical).

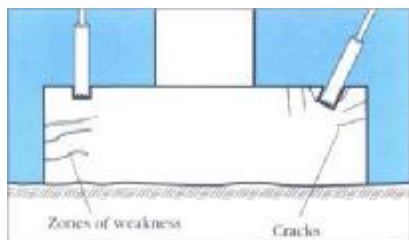

The principal reason for drilling at an angle is to increase the chances of locating cracks.

Sampling sites

should be selected on the basis of a detailed visual inspection of the structure in question and the concreting records.

If the concrete is placed with tremie pipes, these are usually spaced about 4 m apart and about 2 m from the sides of the formwork. At the points where concrete from different pipes merges (a), the likelihood of weak zones being created is greatest.

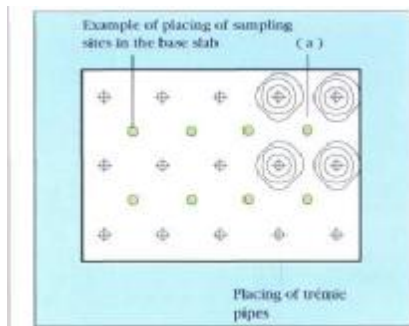

Drilling

should for this reason be carried out through the boundary surfaces shown in the above figure. Some cores should also be drilled out of "good" concrete. The best concrete is presumably to be found where the pipes had been placed.

Testing of underwater concrete is described in greater detail in Chapter 46 of BRO 94. It is convenient to use the drilling record sheets in Part 9, Appendix 9-7, of BRO 94.

It must be noted that the cores shall be treated with the greatest care.

The appearance of an undamaged fracture surface may for instance indicate whether a crack is old or whether it was formed during drilling. Leakage in a drill hole at all times indicates damage.

LABORATORY TESTS

A brief description of how tests for each parameter are to be performed in the laboratory is given below. Some practical hints are also given which should facilitate communication with the sampling unit and should also, it is hoped, lead to greater understanding of the results.

COMPRESSIVE AND SPOTTING STRENGTH

The strength of the test specimens taken from the cores shall be determined in accordance with Swedish Standards. The shape, dimensions and tolerances of the specimens are set out in SS 13 11 11. The compressive strength of the specimens is determined in accordance with SS 13 72 30, and the splitting strength in accordance with SS 13 72 13. The mean and standard deviation are calculated for all test specimens and are normally quoted in the test certificate together with the individual values.

Several strength classes

If there are different strength classes in different parts of the structure, the same calculation is made for each strength class. BBK (Regulations for Concrete Structures) specifies how the results shall be evaluated. With regard to damage criteria, reference is to be made to Part 7 Section 70.4 of BRO 94.

This section states, inter alia, that the splitting strength should be at least 7% of the compressive strength.

Evaluation

In order that the testing institute should have a greater appreciation of the tests and the importance of evaluation, it should be informed of the purpose of the tests. In order to facilitate any communication which may be necessary to obtain additional information, the sketch referred to in the section "Drilling in the field" should be marked with e.g. the number of the structure.

CHLORIDE CONTENT

The concentration of water soluble chloride ions as a proportion of the weight of cement is determined at different levels in a concrete structure. On the basis of these values, a chloride profile can be plotted which shows the chloride ion concentration as a function of the distance from the surface of the concrete.

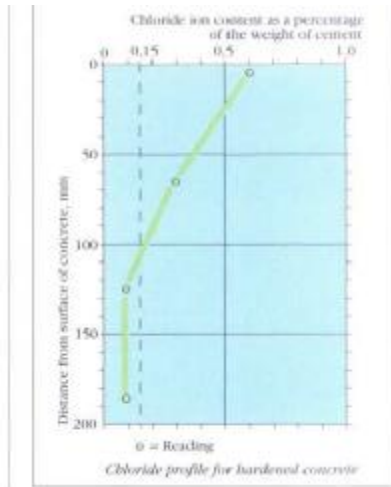

Determination

The chloride ion concentration can be determined in accordance with SS 13 72 35. Tests according to this standard are performed only in well equipped laboratories. Usually, however, the chloride ion concentration is determined in both the field and the laboratory in accordance with the RCT method. Note that e.g. the RCT method also dissolves a certain quantity of bound chloride ions, and the results must therefore in these cases be adjusted.

FROST RESISTANCE

The term frost resistance denotes the ability of concrete to resist repeated freezing. Frost resistance is dependent, inter alia, on air content and on the size and distribution of the air bubbles.

Frost resistance is enhanced if there are many small air bubbles, water-cement ratio is limited (<0.45) and vibration and curing are performed with care.

Investigation

For the investigation of frost resistance, test specimens of 100 mm diameter should be used. The laboratory investigation is performed on a 50 mm thick test specimen sawn out of a core, which is wetted in a bath of chloride solution or pure water. The specimen with its bath is subjected to repeated freezing cycles.

Loss of concrete from the specimen is measured after different numbers of freezing cycles. The test is normally stopped after 56 cycles. One cycle corresponds to 24 hours. Concrete of poor frost resistance may decompose into its constituents after 15-20 cycles, while concrete of very good frost resistance stands up to 200 cycles without visible damage.

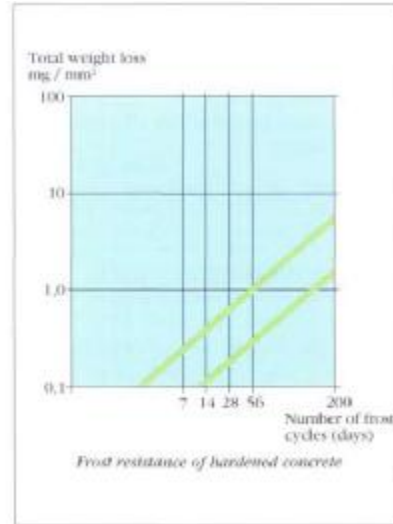

The test is carried out in accordance with SS 13 72 44, Procedure III. The number of test specimens shall be at least 6.

MICROSCOPIC ANALYSIS

Concrete is a composite material principally consisting of aggregate, paste (cement, lime, silica fume, fly ash and air bubbles), water etc. The properties of concrete are to a high degree determined by the properties of its constituents and the way these interact.

A number of parameters which have great significance for concrete can be studied in a single sample by microscopic analysis.

The analysis usually determines the type of binder, the additive content (slag and fly ash), water-cement ratio, degree of hydration and carbonation.

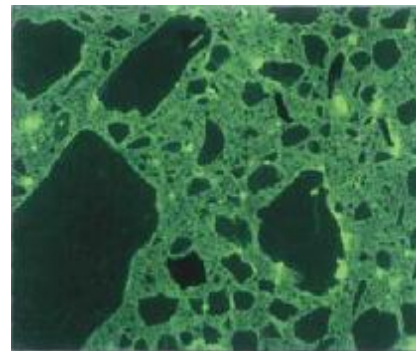

Fig. Concrete with water-cement ratio = 0.4.

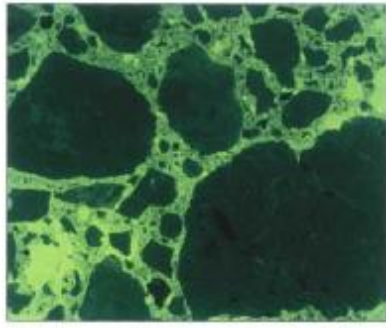

Fig. Concrete with water-cement ratio = 0.55.

As a rule, however, microscopic analysis must be combined with other methods of evaluation.

The quantity of air bubbles and the pore structure are usually described by measuring the following parameters under a microscope:

- air content
- specific surface (size)
- spacing factor (distribution).

Hardened concrete

The properties of hardened concrete are also determined by how good the interaction is between aggregate, paste and air, and how well these interact with other materials.

Mix proportions, crack structure, pore filling, adhesion between aggregate and paste, and adhesion to other materials, are also significant.

Microstructure

An inappropriate microstructure may result in damage which in turn further affects the microstructure.

One example which may be mentioned is that if cement content is too high, shrinkage may be excessive, resulting in microcracking.

As a rule, damage can be attributed to one or more of the following factors:

- wrong material composition
- wrong or defective workmanship
- inappropriate material combinations
- inadequate specifications, etc.

OTHER TEST METHODS

Under other test methods, radar measurement, ultrasonic pulse measurement and thermography are described in varying degrees of detail.

Apart from these methods of measurement, it is possible in the laboratory, using chemical analysis, scanning electron microscopy, X-ray diffraction etc, to find what constituents a certain concrete contains.

It should also be mentioned that radiography and gamma radiography can be used to locate reinforcement or other embedded fixtures. Cracks and cavities can also be detected.

The equipments are suitable for detailed studies of faulty areas which have been located in some other way. In larger concrete structures such strong radiation sources are required that comprehensive safety arrangements are necessary.

Modal analysis of concrete structures, for instance bridges, is a method of evaluation which is under development. Briefly, the bridge is made to oscillate and resonant frequencies, mode shape, damping etc can be measured.

By monitoring a structure during several measurement events separated in time, an estimate can be made of the development of any damage.

Modal analysis is principally useful in determining whether there are losses of prestress or fatigue fractures. In Sweden, this method has been used on a trial basis for a prestressed concrete bridge.

ULTRASONIC MEASUREMENT

Ultrasonic measurement is a common method used to check for, and detect, internal defects in e.g. metals.

At present it is not possible to detect delamination or cavities in concrete. Development is in progress.

Ultrasonic testing in concrete is at present confined to measurement of the velocity of propagation of sound in order to obtain an indirect estimate of the strength of concrete.

THERMOGRAPHY

Thermography is a method in which the surface of interest is photographed with an infrared camera. Under favourable conditions, cavities and delaminations can be detected. It is obviously necessary for these defects to give rise to temperature differences. As in the case of ultrasonic measurement, the method is under development.

INVESTIGATION OF PRESTRESSING CABLES

Owing to defects in the original grouting operation, a prestressing cable may have to be regouted. Examples of damage which may occur due to defective grouting are frost splitting due to ponding of water in voids, cracks due to cable fracture or spalling of cover due to corrosion of the cables. These defects can be located by ultrasonics, radiography or inspection through boreholes. In Clause 5.3 of Report No 17:1984 of the Nordic Association of Road Engineers, "Prestressed concrete bridges - inspection and repair", these inspection methods are described in detail. Ultrasonic measurement and the use of X-ray and gamma radiation have been described before in this chapter. The drilling of holes to locate cavities using an endoscope with fibre optics, which is not based on detection by ultrasonic investigation or radiography, can be an expensive procedure since many holes must presumably be drilled. It should be pointed out, however, that drilling a hole in the wrong place may obviously have serious consequences. Once a cavity has been located, the inspection hole can be used to effect repairs.

Bottom profiles can be surveyed with a manual sounding line, electronic depth meter, echo sounder and high frequency sonar. This survey is carried out to find whether scour has taken place near the bridge.

MANUAL SOUNDING LINE

This measurement is mostly carried out along the edge beams using a measuring tape with a weight of at least 1 kg attached.

On the basis of these measurements, the bottom profiles along the bridge can be plotted. Flowing water can cause difficulties in measurement.

ELECTRONIC DEPTH METER

The equipment comprises a pressure transducer with cable connection to the surface where the level is read by a receiver unit. As in the case of manual sounding, flowing water may cause difficulties in measurement.

ECHO SOUNDING

In flowing water, the use of echosounding equipment attached to a rod is advantageous. The readings are shown directly on a display. In fast flowing water the measurement may be disturbed by air being drawn down around the transducer.

A recording echo sounder mounted on a boat is another alternative. The boat is rowed for instance along the bridge, and the depth is recorded continually.

It is convenient for the positions of supports etc also to be recorded. Any variation in the speed of the boat can in this way be compensated for when the bottom profile is plotted.

HIGH FREQUENCY SONAR

The sonar measures sections in any direction from fixed base points. Measurements can be made in flowing water.

The equipment is suspended from the deck slab at the required number of points. It is best for these measuring locations to be near supports. The results are immediately displayed on a monitor.

The measurements can be stored in a computer, after which bed profiles or contoured maps can be plotted. The position of the transducer must at all times be accurately fixed, otherwise misleading results are obtained.

Before the surfacing and waterproofing are opened up for inspection of the concrete situated below, pulse radar measurement of the waterproofing should be made. See the chapter "Inspection procedure", section "Special inspection - waterproofing", p. 125.

VISUAL INSPECTION

When leakage is detected or suspected, a sample must in the first place be taken within the area assumed to be affected by the leakage. A reference sample should always be taken from a surface where no leakage is suspected.

Windows

Samples are conveniently taken in "windows" by drilling a core through the surfacing, concrete protection course if any, and waterproofing. Drilling is to be carried out in stages, course by course. Each course is to be inspected before the next level is exposed.



Fig. Core drilled window.



Fig. Sawn window.

On a bridge with gravel carriageway or gravel surfacing, the courses above the waterproofing and concrete protection course must be removed. This can be done by digging a pit, or if the bridge has surfacing thicker than 0.5 m, by digging inside a precast concrete ring.

Investigation of concrete

The investigations of the concrete in the deck slab which may have to be performed are as follows:

- Visual checking of concrete surfaces inside the "windows"
- Measurement of chloride content
- Tests for frost resistance
- Tests for strength
- Visual checking of drilled samples

During visual checks in windows,

an assessment is made whether the concrete is weathered or eroded. The depth to which the damage has penetrated must also be studied.

If the damage extends down to or below the top reinforcement in the slab, the extent of damage must be established.

The concrete is chipped away with a hammer or cold chisel. The fracture surfaces are carefully studied. They can provide useful information regarding the state of the concrete.

The effects of different chloride contents

In a number of major repairs on structures which had originally been made of concrete without the addition of air entraining agents, in which cores have been drilled and analysed parallel with visual observations, the following relationships have been found. At chloride contents less than 0.15%, expressed in terms of the water soluble chloride ion concentration as a percentage by weight of cement, both cement paste and aggregate are crushed or cracked during demolition. At chloride contents exceeding 0.3%, less work is needed

and fracture usually occurs at the boundary between cement paste and aggregate. The aggregate often leaves clear impressions in the cement paste.

Poor adhesion between cement paste and aggregate may thus indicate high chloride contents.

Investigation of chloride content

need not be made where de-icing salt has not been spread and visual inspection shows concrete quality to be good. If it is uncertain whether or not de-icing or dust abatement by chlorides has previously been carried out, the chloride content should be investigated.

Weathered concrete has no strength and no bond with reinforcement. The loadbearing capacity of the deck slab may therefore have been considerably reduced.

Other concrete investigations

are described in the section "Concrete", p. 138.

REPAIR AFTER INSPECTION**Concrete surfaces**

can be repaired with bituminous mastic if the area is not larger than 0.2 m², see BRO 94, Part 9. Owing to the risk that galvanic couples may be formed, the mastic must not come into contact with reinforcing bars. If the area is larger or the depth greater, >20 mm, repair shall be made using cement based products; see also BRO 94, Clause 74.32.

Waterproofing can be repaired

using the type of waterproofing on the bridge. All waterproofing can however be repaired with bituminous mastic intended for bridge waterproofing; see BRO 94, Part 9.

In order to prevent leaks when samples are taken, it is necessary that waterproofing be repaired with an overlap of at least 50 mm. The easiest way of doing this is to measure the thickness of surfacing in the test hole down to the waterproofing and to drill another hole. The diameter of this should be at least 100 mm greater than that of the test hole.

This hole is to be concentric with the first hole and drilled down to ca 20 mm above the waterproofing. The surfacing is then to be removed carefully with a cold chisel and hammer, in pieces from the top down.

The last 20 mm above the waterproofing is to be heated carefully with a small LPG burner, so that the layer can be removed without damage to the waterproofing.

Surfacing can be repaired

with bituminous mastic if the diameter of the hole is <200 mm. Larger holes require mastic asphalt or bituminous mastic which is mixed with bituminised chippings in order to have greater stability.

Note that if the waterproofing has been repaired with membrane waterproofing or a waterproofing mat, the repair must cool down before the first course of mastic asphalt or bituminous mastic is laid. The thickness of the first course above the waterproofing should not exceed 20-30 mm. This course must also cool down before the next course is applied, otherwise there is a risk that the repair overlap will float.

In all repair, the hot compound must be applied in courses which must cool down. This also has the effect that shrinkage effects are minimised.

Special measurements and sampling in steel structures are carried out to detect internal and external defects in welds and parent material, and to investigate the properties of the steel.

Problems in older structural steel are often associated with uneven quality and inadequate ductility.

The basic Bessemer process

often produced steel with high contents of phosphorus and nitrogen. This had the result that the material was prone to ageing and increasingly brittle as time went on.

During the 1950s, however, the process was improved. The converter began to be blown with oxygen enriched air instead of pure air, and this had the result that impurities were reduced. Ductility and quality were improved.

In the 1960s the process was superseded by the Kaldo LD method, and this further improved quality.

Brittle fracture is characterised by the suddenness of failure and very little plastic deformation. It is an unstable failure, i.e. the energy stored in the structure is sufficient to maintain the failure process.

The most common causes of brittle failure are listed below in rank order.

- Steel with high contents of impurities
- Low temperature.
- Mechanical damage such as dent made by an impact.
- High loads.

Welds in old steel

It is a general rule that older steels shall not be welded unless the material has been analysed and the other strength properties have been established. Normally, however, additions, alterations and repairs are made with bolted connections.

If welding is to be carried out on older steel structures, an investigation must first be made whether this is realistic. This means that a weldability investigation must be made.

NONDESTRUCTIVE TESTING

Nondestructive tests on steel can be made by the magnetic particle method and the liquid penetrant method.

The magnetic particle method

is used to indicate cracks, folds, pores, undercuts and similar defects on or very near the surface. Magnetic particle tests are to be made in accordance with SS 11 44 01. The higher the standard of surface finish, the greater the sensitivity of the method.

The method can only be used on ferromagnetic materials.

Paint and impurities must be removed before the test.

In order to facilitate visual examination, paint of a contrasting colour (white strippable lacquer) is to be applied before the test.



Fig. Permanent magnet.

Permanent magnet and electromagnet

Both a permanent magnet and an electromagnet can be used in the test. The area to be tested is magnetised with the magnet.



Fig. Electro magnet.

BRIDGE INSPECTION
Measurement, Sampling - Description
STEEL

During magnetisation magnetic powder made into a slurry with a suitable liquid such as paraffin is applied to the work-piece. If a crack is found, the flow of magnetic powder is diverted and a leakage flow occurs across the crack.

This leakage flow causes magnetic polarisation of the edges of the crack.

It is convenient for defect indications to be recorded by photography.

Defects or imperfections which are detected are normally followed up by radiography or ultrasonics. See the chapter "Inspection procedure - special inspection of welds", p. 124.



Fig. Liquids for penetrant test.

Liquid penetrant testing

is used to indicate cracks, folds, pores, undercuts and similar defects on or near the surface. The higher the standard of surface finish, the greater the sensitivity of the method. Liquid penetrant testing is to be carried out in accordance with SS 11 45 01. The method can also be used for non-ferromagnetic materials such as aluminium.

Prior to the test, paint, oil, water, dirt and other impurities must be removed from the intended work area.

A penetrant liquid is sprayed, poured or painted on the surface. After some time (5 seconds - 30 minutes) the liquid will have penetrated into any cracks or other surface defects. Excess penetrant liquid is then removed with a cleaning fluid, and a white liquid called developer is applied.

If there are defects, the penetrant is drawn to the surface where it spreads into the developer.

After developing the surface aminated in a suitable light.

It is convenient for defect indications to be recorded by photography.

Defects or imperfections which are detected are normally followed up by radiography or ultrasonics. See the chapter "Inspection procedure - special inspection of welds", p. 124.

DESTRUCTIVE TESTING

**TESTS ON OLDER
STRUCTURAL STEEL**

If it is necessary to investigate the strength of the material, sampling and testing should be performed in accordance with Swedish Standards for acceptance tests on metallic materials.

- **Tensile tests** in accordance with SS 11 01 20 and SS 11 21 10.
- **Impact tests** in accordance with SS 11 01 51, SS 11 23 51 and SS 11 23 52.
- **Bending tests** in accordance with SS 11 01 80 and SS 11 26 26.
- **Determination of hardness** in accordance with SS 11 25 10 HB, SS 11 25 16 HV and SS 11 25 12 HRc.
- **Chemical analysis** in accordance with SS 11 01 05.

The sizes of test specimens for destructive tests on steel in bridges are set out below.

Impact tests

70 mm x 70 mm or 200 mm length x 25 mm width. It is essential for rolling direction to be marked.

BRIDGE INSPECTION
Measurement, Sampling - Description
STEEL

Tensile tests

Flat test piece 400 mm length x 50 mm width. Round test piece 200 mm length x 50 mm width. A round test piece can be taken from the thicker flange where only a small test piece can be taken.

Test pieces are to be taken out on the instructions of the designer.

In a static test, the yield point, ultimate tensile strength, elongation at failure and notch toughness are determined.

Notch toughness test

In certain cases it is necessary for the material to have sufficient toughness. This is determined by notch toughness testing. This is performed on at least three test pieces and at the lowest operating temperature. The mean value of notch toughness shall be greater than 27 J, and the lowest individual value shall be not less than 20 J.

Determination of hardness

This gives an indication of the ultimate tensile strength of the material and may for instance be used if tensile test pieces are not taken out. UTS is approximately 1/3 of Brinell hardness (HB). (NOTE that UTS is given in the same units as HB).

For structures subject to static loading, one third of UTS can be used as design stress.

Chemical analysis

Analysis is performed mainly on steel which is to be welded. The sample for analysis is to be taken from the centre of the test piece.

When samples are taken, the material must not be exposed to heat.

The C, Si, Mn, P, S and N contents are normally determined. In more special cases the Cr, Ni, Mo and Cu contents should also be determined.

The analytical determinations should in certain cases be complemented by metallographic investigation of e.g. grain size, grain boundary-carbides and non-metallic inclusions.

CHECK ON SURFACE TREATMENT OF STEEL

NONDESTRUCTIVE TESTING



Coat thickness determination

An electric dry film meter is used to measure the thickness of a coat of paint on a magnetic substrate. This is a digital instrument on which the coat thickness in pm can be directly read.

It is important that an instrument with the correct scale for the paint coat in question should be used. The instrument must be calibrated before measurement. This is done on shot blasted surfaces of nonmagnetic metals or on plastics films of known thicknesses.

Check on the watertightness of coats of paint

A pore detector is used to find whether the coat of paint is porous. One type works on low voltage - 9V - and the other type on high voltage - up to 50,000V.

The low voltage instrument is used on coats of paint up to 500 pm. The practical lower limit of application of the high voltage instrument is usually 200 pm.

Both types of instrument are used in broadly the same way. The instrument is earthed in the object of measurement and the probe is traversed over the surface. When a pore is found, a flashover occurs between the probe and the surface of the paint - in reality the steel below the paint.

An acoustic signal is then heard, and on the high voltage instrument there is also a spark.

BRIDGE INSPECTION
Measurement, Sampling - Description
STEEL

DESTRUCTIVE TESTING

Adhesion test

An adhesion test is performed by gluing tensile test pieces to the paint and subjecting these to a pull-off force in tensile testing equipment. The test is performed in accordance with SS 18 41 71. The adhesion is given in MPa.

BOLTED AND RIVETED CONNECTIONS

BOLTED CONNECTIONS

Bolted connections are assigned to the following classes:

51 Bearing-type connection. Normal tightening.

52 Bearing-type connection. Normal tightening (close tolerance connection)

53 Friction-type connection.
S3 = bolts are preloaded

S1F Bearing-type connection. F = bolts are preloaded.

S2F Bearing-type connection. F = bolts are preloaded.

The inspection is made with regard to damage and abnormal deformations in the connection, and damage to the bolts.

Checks on connections with normal tightening are made with a large spanner. Loose nuts are tightened and secured against loosening by a punch mark on the threads.

Checks on high strength friction grip connections with regard to the specified tightening torques for the bolts are made with an accurately calibrated torque spanner.

Recommended values are as follows:

Strength class	Bolt diameter mm	Tightening torque Nm
8.8	M16	200-250
8.8	M20	300-400
8.8	M22	450-600
8.8	M24	650-750

For bolts in strength class 10.9 the tightening torque shall be increased by 25%. If a bolt is damaged, or a nut is loose, in a high strength friction grip connection all bolts and nuts in the connection must be replaced.

At the time of checking, the nut is to be tightened a little (ca 5°). Once the static friction has been overcome, the torque indicated shall exceed the minimum torque in the above table.

RIVETED CONNECTIONS

All rivets are to be checked by a light blow on the rivet head with a hammer (weight ca 0.35 kg).

There shall be no movement in the rivet. This can be checked, for instance, by holding a finger against the edge of the rivet as it is struck.

A check is also to be made that there is no slip in the connection.

MEASUREMENT OF CRACK DEPTH

The principle of operation of this instrument is as follows:

If an electric current is impressed on the surface of a piece of metal and the voltage drop is measured over a certain distance, the voltage drop on a surface free from defects is the same regardless of where the measurement is made. If there is a crack in the region where the measurement is made, the voltage drop increases. The deeper the crack, the larger is the voltage drop.

VIBRATION MEASUREMENT

A machine which has abnormally high vibration wears out more rapidly. Even an imperceptible rise in vibration level increases the temperature, and the bearings are worn more rapidly. Special, portable or stationary, equipment is available for vibration measurement.

SHOCK PULSE MEASUREMENT

The shock pulse method (SPM method) measures the magnitude of the mechanical shocks generated in damaged rolling bearings. Different makes of meter are available.

STROBOSCOPE

An instrument which can generate very short flashes of light. A rotating mechanical component is illuminated and the number of flashes per unit time is adjusted so that it coincides with the rate of rotation; this freezes the picture.

STETHOSCOPE METHOD

The mechanical component can be listened to through the stethoscope. In the simplest form of this method, a screw driver, wooden stick or similar implement can be used.

CONTOM CONTROL

Analysis of oil in a hydraulic system for impurities. The instrument is connected directly to an in-line coupling of the Specmatest M 16 type, and an oil sample is obtained for immediate analysis.

SPECTROMETRIC OIL ANALYSIS

Oil samples are taken at definite intervals in a special sampling bottle. The quantity of every element is measured by an atomic absorption spectrophotometer in ppm, i.e. the number of parts of the element per million parts of oil.

The method is used for oil where moving parts are in contact.

METERS FOR PRESSURE, FLOW RATE AND TEMPERATURE

Instruments for performance analysis in a hydraulic system.

LASER

Measuring instruments which can determine length, thickness, angles, vibrations, planarity, straightness, angular frequency, etc.

